

2024 Reliability Needs Assessment (RNA)

A Report from the New York
Independent System Operator

DRAFT

For October 24, 2024 OC

Table of Contents

EXECUTIVE SUMMARY	6
Actionable Reliability Need in New York City	6
Demand Growth and Uncertainty	7
Narrowing Statewide Reliability Margins	9
Exploring Uncertainty: Scenarios and Risks	10
Next Steps	12
INTRODUCTION	14
BACKGROUND	16
State of the Grid	16
Regulatory Policy Activities Affecting the Reliability Needs Assessment.....	22
2023-2032 Comprehensive Reliability Plan	25
Updated Reliability Criteria and Compliance Activities.....	26
ELECTRIC GRID TRENDS	28
Demand Growth and Uncertainty.....	28
Development of Large Loads.....	32
Resource Additions and Removals	36
Gas Unavailability.....	38
ACTIONABLE RNA RESULTS	39
Resource Adequacy Results	40
Statewide System Margin	44
Transmission Security Results	46
New York City Transmission Security Margin	48
Local Non-BPTF Reliability Assessment.....	50
EXPLORING UNCERTAINTY: SCENARIOS AND RISKS.....	52
Additional Queue Projects Scenario.....	52
Offshore Wind Scenario	53
Additional Firm Gas Generation Scenario	54

Demand Response in Transmission Security Scenario	54
High Demand Forecast Scenario	55
CHPE Unavailability Scenario	56
Additional Generation Retirements Scenario	57
FINDINGS	60
New York City Reliability Need.....	60
Reducing Statewide Reliability Margins.....	61
Uncertainty in the Planning Horizon.....	61
NEXT STEPS AND FUTURE STUDIES	63

List of Figures

Figure 1: New York City Margin Forecast Uncertainty.....	7
Figure 2: Winter Peak Demand Forecast Impacts - MW.....	8
Figure 3: NYCA Winter Peak Forecasts.....	9
Figure 4: Narrowing Statewide Reliability Margins.....	10
Figure 5: Impacts of Key Uncertainties to Reliability Margin.....	11
Figure 6: NYISO's Comprehensive System Planning Process.....	14
Figure 7: NYCA Load Zones.....	17
Figure 8: Summer Installed Capacity (MW) by Fuel Source – Statewide, Upstate, & Downstate New York: 2024.....	18
Figure 9: Energy Production by Fuel Source (GWh) – Statewide, Upstate, & Downstate New York: 2023.....	19
Figure 10: Statewide Resource Availability: Summer 2024.....	20
Figure 11: Historical Average Hourly Demand versus Actual Yearly Summer Peak Demand.....	21
Figure 12: Historical Generating Capacity Fuel Mix in New York State: 2005-2023.....	21
Figure 13: NYPA Units Affected by the Legislation.....	25
Figure 14: 30-Year NYCA Summer and Winter Peak Forecasts.....	29
Figure 15: NYCA Baseline Summer & Winter Peak Forecast Impacts - MW.....	30
Figure 16: Higher Demand Scenario Peak Forecast Impacts.....	31
Figure 17: Large Load Projects in the NYISO Interconnection Queue.....	33
Figure 18: RNA Large Load Forecast Assumptions.....	34
Figure 19: Large Load Impact on NYCA Baseline Load Forecast.....	34
Figure 20: Base Case Additions, Removals, Net Imports, and Load.....	37
Figure 21: Existing and Additional Renewable Fuel Mix by 2034 - MW.....	37
Figure 22: NYCA Resource Adequacy LOLE Results.....	41
Figure 23: NYCA Resource Adequacy Annual, Summer, Winter LOLE Results.....	41
Figure 24: NYCA Resource Adequacy Results with Additional Reliability Indices.....	42
Figure 25: Zonal Resource Adequacy Margins - ZRAM (MW).....	43
Figure 26: Zonal Resource Adequacy Margins - ZRAM (MW).....	44
Figure 27: Summer Peak Statewide System Margin.....	45
Figure 28: Winter Peak Statewide System Margin.....	45
Figure 29: 2034-2035 Winter Peak Day Reserve Levels.....	47
Figure 30: Winter Peak Steady State Transmission Security N-1-1 Thermal Overloads.....	47
Figure 31: Summer Peak Steady State Transmission Security N-1-1 Thermal Overloads.....	48
Figure 32: New York City Transmission Security Margin.....	49
Figure 33: New York City Transmission Security Margin Hourly Curve - 2034.....	50
Figure 34: Greenwood 138 kV TLA.....	51
Figure 35: Greenwood 138 KV TLA Deficiency.....	51
Figure 36: Additional Queue Projects Scenario NYCA LOLE Results.....	53
Figure 37: Additional Offshore Wind Scenario NYCA LOLE Results.....	53
Figure 38: Additional Firm Gas NYCA LOLE Results.....	54
Figure 39: Baseline Demand Forecast vs High Demand Forecast (MW).....	55
Figure 40: High Demand Scenario NYCA LOLE.....	56
Figure 41: Scenario without CHPE LOLE Results.....	57
Figure 42: Aging Fossil Fuel Capacity.....	58

Figure 43: Impact of Potential Retirements	59
Figure 44: New York City Margin Forecast Uncertainty	60
Figure 45: Scenario Reliability Margins	61
Figure 46: Reliability Planning Process	63

Executive Summary

This 2024 Reliability Needs Assessment (RNA) evaluates the reliability of the New York bulk electric grid from 2028 through 2034, considering forecasts of peak power demand, planned upgrades to the transmission system, and changes to the generation mix over the next ten years. The RNA assesses a “base case” set of assumptions to identify actionable Reliability Needs if there is a violation of applicable reliability criteria. To further inform an understanding of potential system conditions over the ten-year horizon, the RNA also assesses various scenarios to identify risks to reliability and consider potential solutions necessary to address reliability risks. For this RNA, the results are notably impacted by the assumed retirement of the NYPA small gas plants, the forecasted demand growth from large demand facilities (“large loads”) and electrification, and the assumed unavailability of non-firm gas generation during the winter peak period.

Actionable Reliability Need in New York City

This 2024 RNA identifies a Reliability Need beginning in summer 2033 within New York City primarily driven by a combination of forecasted increases in peak demand and the assumed retirement of the NYPA small gas plants. Accounting for these factors, the planned bulk power transmission system will not be able to securely and reliability serve the forecasted demand in New York City. When accounting for forecasted economic growth and policy-driven increases in demand, the New York City (Zone J) will be deficient starting in summer 2033 by as much as 17 MW for 1 hour and increasing to 97 MW for 3 hours in summer 2034 on the peak day during expected weather conditions. The Reliability Need occurs within Con Edison’s transmission district. Therefore, Con Edison is designated as the Responsible Transmission Owner and required to submit a regulated backstop solution to address the need, which may be triggered if sufficient market-based solutions do not materialize.

Figure 1 shows the impact of the NYPA small gas plant retirements in 2031 and the potential New York City deficiency when accounting for the higher bound of the demand forecast. The summer margin improves in 2026 with the scheduled addition of the Champlain Hudson Power Express (CHPE) connection from Hydro Quebec to New York City. Thereafter, the summer margin reduces through time as demand grows within New York City due to electrification of heating and transportation. Without the CHPE project in service or other offsetting changes or solutions, the reliability margins would continue to be deficient for the ten-year planning horizon.

Figure 1: New York City Margin Forecast Uncertainty

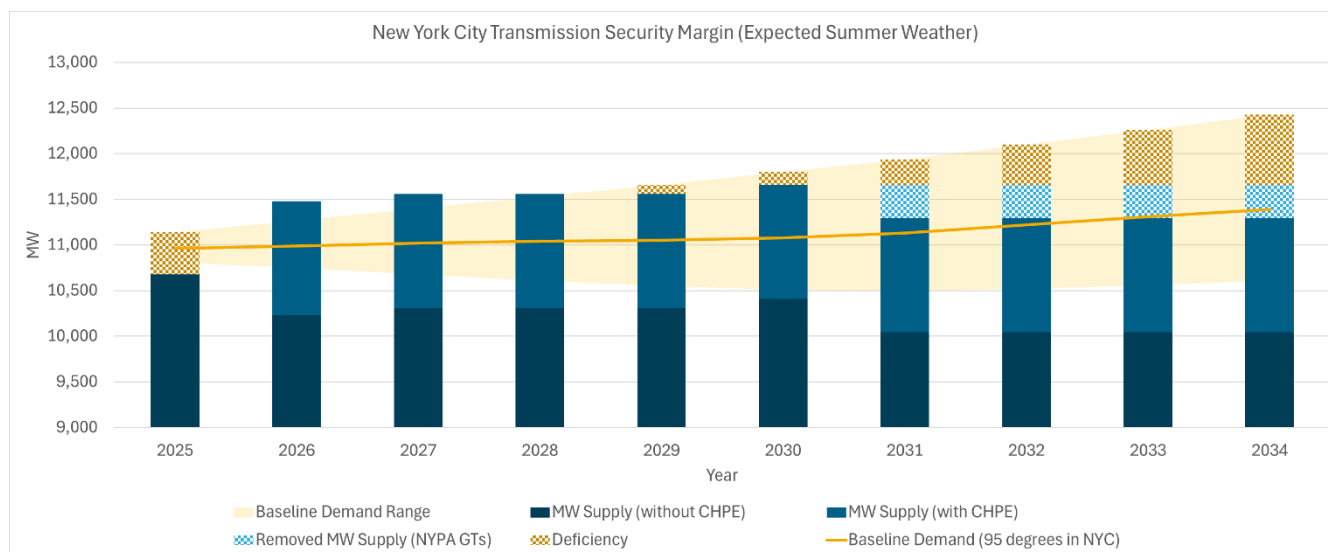

Furthermore, Con Edison has identified reliability violations in the Greenwood 138 kV transmission load area. These violations are on elements of the non-Bulk Power Transmission Facilities and are, therefore, not actionable as Reliability Needs under the RNA. This RNA describes these violations for developers to holistically consider their impact on the reliability of both the Bulk Power Transmission Facilities and non-Bulk Power Transmission Facilities when identifying or developing proposed solutions.

The Reliability Need could be met by combinations of solutions including new generation, retention of planned generation retirements, transmission, energy efficiency, demand response measures, or changes in operating protocols. Specifically, scenarios performed in this RNA indicate that the deficiency in New York City beginning in 2033 could be resolved by resources currently under development but not yet in the RNA base case. Other scenarios identified that the deficiency could be much greater if there is a load increase or unplanned generator retirement beyond what is assumed in the base case.

Demand Growth and Uncertainty

One of the most significant factors driving the reliability need and risks in this RNA is the increase in peak system demand, which is forecasted to grow by approximately 7,300 MW in winter and 2,300 MW over the next ten years. To demonstrate the drivers of demand forecast, **Figure 2** breaks out different components of the winter peak load forecast over the planning horizon. While “base load” decreases due to behind-the-meter resources and energy-efficiency, it is more than offset by large increases in the winter peak load caused by large loads, electric vehicles, and, especially, building electrification.

Figure 2: Winter Peak Demand Forecast Impacts - MW

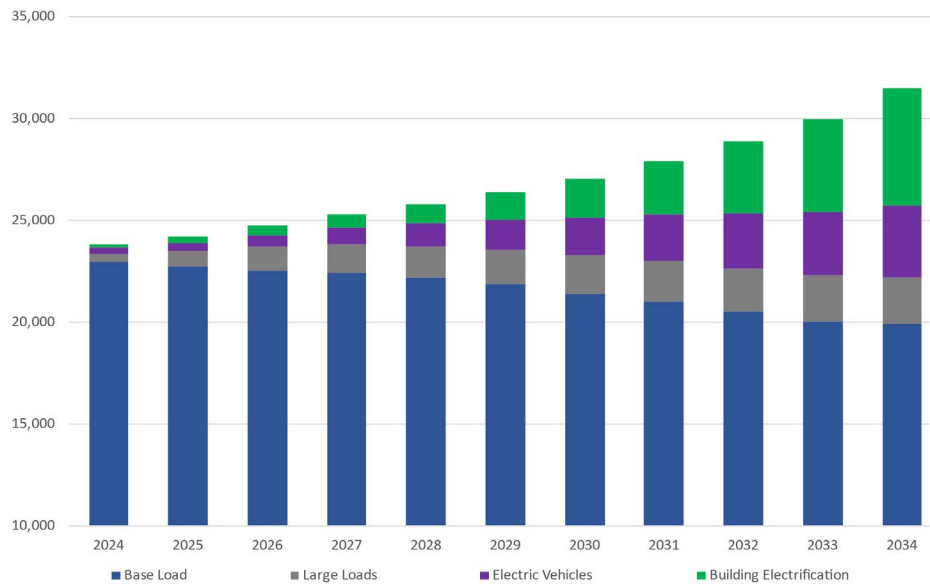

The use of demand scenarios has become increasingly important as the nature of the load growth significantly evolves from historic patterns. In prior years, the load changes have generally been due to broad trends in economic growth with narrower bands of uncertainty. The current load growth projections, conversely, are tightly tied to specific state policies contributing to the electrification of building conditioning and transportation, as well as the increases in the interconnection of discrete large loads. The timing and magnitude of the latter drivers are materially less certain and must be considered in accounting for the range of outcomes planning studies such as the RNA. The impact of this uncertainty can be seen in the higher and lower band of the winter peak forecasts in **Figure 3**.

Figure 3: NYCA Winter Peak Forecasts

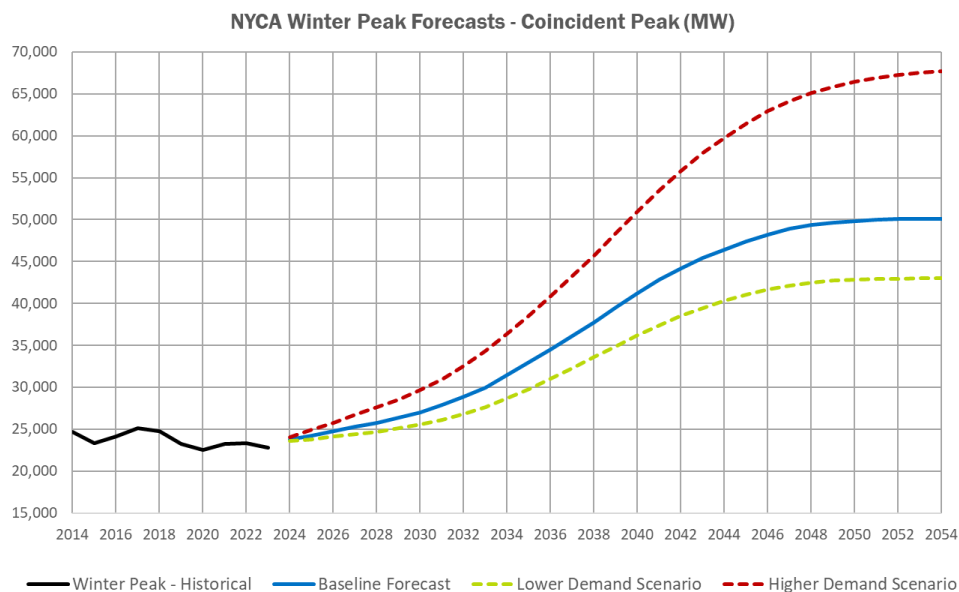

Narrowing Statewide Reliability Margins

This RNA finds that the planned New York grid will meet the statewide resource adequacy criterion throughout the ten-year horizon. Although a violation is not identified, the loss of load expectation approaches the 0.1 event-days per year criterion in 2034. This result relies on the use of emergency operating procedures, such as receiving assistance from neighboring regions and the assumed flexibility of certain large load facilities (*i.e.*, cryptocurrency mining and hydrogen production), during system peak conditions. The forecasted resource adequacy is also heavily impacted by the assumed unavailability of approximately 6,400 MW of non-firm, gas-only generation during winter peak periods.

Recent NYISO reliability studies have identified decreasing, and even negative, statewide system margins for normal operating conditions without consideration of emergency operating procedures. This 2024 RNA continues to observe a declining statewide system margin due to increased demand, anticipated generation retirements without adequate new generation addition, and the unavailability of non-firm gas during winter peak conditions. A negative statewide system margin, on its own, is not a criteria violation, but it is a leading indicator of the system’s inability to securely serve demand under normal operations while fully maintain operating reserves.

The significant negative statewide margins present a unique challenge not seen before in NYISO’s planning studies. Transmission facility overloads are observed in 2034; not because of constraints on

specific transmission facilities but because there is insufficient generation reserves statewide necessary to reliably serve the demand across the system. This potential lack of operating reserves is a significant concern that the NYISO will closely monitor and re-evaluate in future planning studies.

Figure 4: Narrowing Statewide Reliability Margins

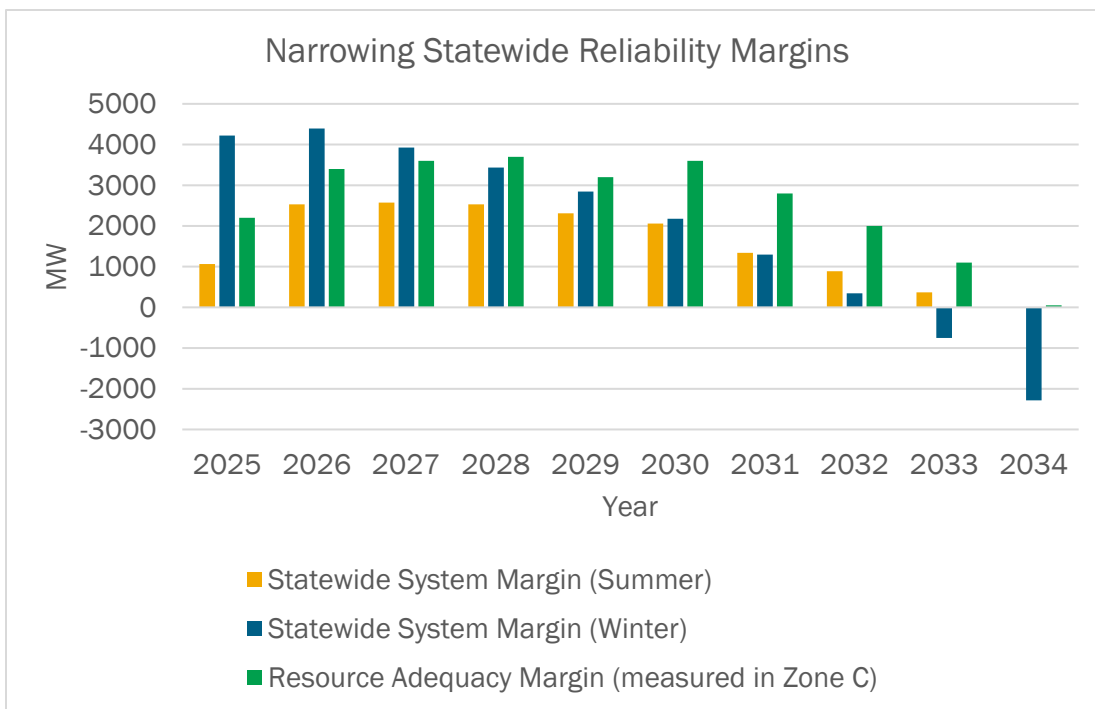

Exploring Uncertainty: Scenarios and Risks

This RNA uses scenarios, which although not actionable to identify needs, inform potential solutions and assess risks to the bulk electric grid. Scenarios test the robustness of the need assessment and are particularly useful when there is growing uncertainty in forecasted generation, demand, and transmission. These scenarios help to identify variations from the base case assumptions that if occur in the future could have a positive reliability impact (*e.g.*, additional resources to those that met the base case inclusion rules) or a negative reliability impact (*e.g.*, delays in proposed projects, additional generation retirements or resources removal, higher demand). Figure 5 summarizes the positive and negative reliability impacts below.

Figure 5: Impacts of Key Uncertainties to Reliability Margin

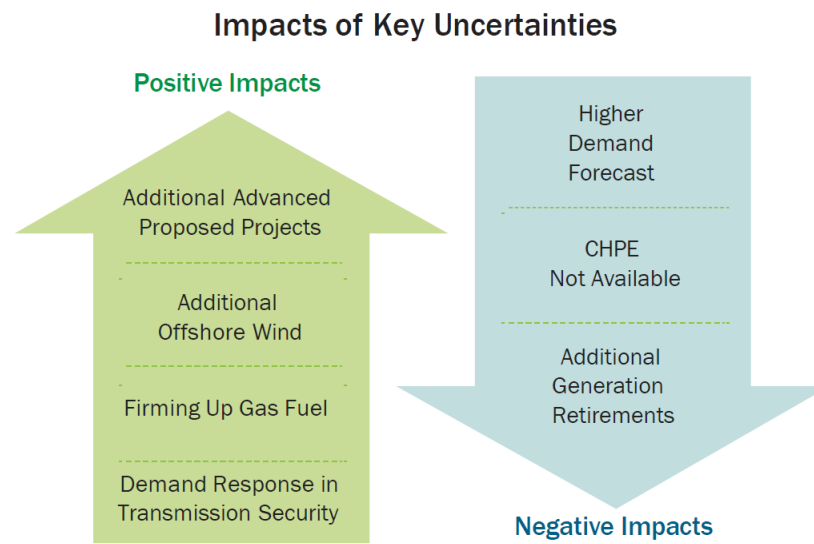

For instance, the results from the following scenarios indicate how the New York City Reliability Need in this 2024 RNA can be resolved and provide additional margin to avoid potential resource adequacy and transmission security violations:

- **Additional New Resources Scenarios:** This RNA includes two scenarios that model additional generation under development but have not yet met the criteria required for inclusion in the RNA base case. One scenario adds 5,000 MW of generation that represents the projects that accepted their cost allocations in NYISO’s Interconnection Process but have not met the other developmental milestones for inclusion in the base case. The second scenario adds 7,000 MW of offshore wind that is necessary to satisfy the CLCPA. These scenarios show how additional generation can resolve the New York City deficiency identified in this RNA, significantly improve statewide resource adequacy, and provide enough system flexibility to resolve the 2034 overloads.
- **Additional Firm Gas Generation Scenario:** This scenario shows that an additional 700 MW of firm gas or dual fuel generation would significantly reduce the identified winter reliability risks. It’s important to note that the modeling of winter fuel risks is expected to evolve in the future, which could have a positive or negative impact to reliability results.
- **Demand Response in Transmission Security Scenario:** The results from this scenario indicated that developments in special case resources (SCRs), distributed energy resources (DERs), and other demand response programs may effectively resolve the New York City Reliability Need and provide more margin to mitigate overloads found across the state.

Other scenarios performed in this RNA, however, inform system risks that can exacerbate the identified Reliability Need in New York City or result in significant statewide resource adequacy deficiencies. These scenarios and results are as follows:

- **Large Load Flexibility Scenario:** Over 2,000 MW of large demand facilities (“large loads”)

are expected to be served in New York within the next decade. Approximately 1,200 MW of these large loads are cryptocurrency mining and hydrogen production facilities, and the RNA base case assumes these loads are flexible to reflect their characteristics based on communication with load developers and recent operating experience. Should these large loads prove not to be flexible during peak demand conditions, this scenario indicates that there would be a statewide resource adequacy violation by 2034 and further reduce the statewide system margin under normal operations. The trend of rapid large load additions appeared within the past few years and is observed across the country with regional variations in the speed and types of loads. It requires continuous monitoring as they come in service, and the NYISO will continue to coordinate with load developers and Transmission Owners.

- **High Demand Forecast Scenario:** As described above, there is growing uncertainty in the demand forecast over the next ten years. The 2024 Load & Capacity Data Report (Gold Book) contains a high demand forecast that represents a higher bound on forecast growth, including faster economic growth and electrification sufficient to meet state policy targets, and includes additional large load growth not included in the baseline forecast. The statewide peak demand forecast could increase by 4,400 MW in winter and 3,270 MW in summer relative to the baseline, resulting in a statewide resource adequacy violation by 2032. This higher demand level would also result in accelerating the New York City deficiency to occur in 2029 and grow to over 1,000 MW by 2034.
- **CHPE Unavailability Scenario:** This scenario shows the impact should the Champlain Hudson Power Express (CHPE) project be unavailable or delayed beyond the RNA study period. It also informs the impact if CHPE cannot inject power into New York City during summer peak conditions. Specifically, this scenario would result in a resource adequacy violation in 2034 and accelerate the New York City deficiency to begin in 2026.
- **Additional Retirement Scenario:** A growing amount of New York's gas-turbine and fossil fuel-fired, steam-turbine capacity is reaching an age at which, nationally, the majority of similar units have deactivated. The retirement of the largest plant in each of the Lower Hudson Valley, New York City, and Long Island localities would result in transmission security deficiencies, with New York City and Long Island being deficient starting 2025.

Next Steps

This RNA identifies that the New York City (Zone J) will be deficient starting in 2033 with a deficiency of 17 MW for 1 hour in summer 2033 that grows to 97 MW for 3 hours in summer 2034 on the peak day during expected weather conditions when accounting for forecasted economic growth and policy-driven increases in demand. Following approval of this RNA by the NYISO Board of Directors, the NYISO will commence the process detailed in its procedures to seek system updates that are relevant to reducing, or eliminating, the identified Reliability Need. This process is for the purpose of minimizing unnecessary solicitations of solutions to the Reliability Needs. The NYISO will request updates to the status of proposed projects, such as Local Transmission Owner Plans, proposed generation and transmission additions, development of discrete large loads, demand response, and other status updates relevant to reducing, or eliminating, the Reliability Need. The NYISO will consider timely updates that meet the inclusion rules, and if necessary, will solicit solutions to any remaining Reliability Need.

The NYISO would then proceed to assess the completeness, viability, and sufficiency of each of the solutions, and determine if the NYISO needs to evaluate and select the more efficient and cost-effective transmission solution(s) to satisfy the needs. This work will lead to the development of the Comprehensive Reliability Plan (CRP). The CRP provides the plan to maintain system reliability over the ten-year planning horizon and documents the solutions determined to be viable and sufficient to meet any identified Reliability Needs. If applicable, the CRP ranks any regulated transmission solutions submitted for the Board to consider for selection of the more efficient or cost-effective transmission project. Another focus of the CRP will be to further explore the grid trend uncertainties highlighted in this RNA, which can be incorporated into the 2026 RNA and future STARS to identify any future reliability needs.

Introduction

This report sets forth the NYISO’s 2024 Reliability Needs Assessment (RNA) findings for the study period of years 4 through 10 following the start of the RNA (*i.e.*, years 2028 through 2034). The RNA is the first of two main components of the Reliability Planning Process (*see* **Figure 6**). The RNA is performed to evaluate electric system reliability according to resource adequacy and transmission security criteria over the study period.

Figure 6: NYISO’s Comprehensive System Planning Process

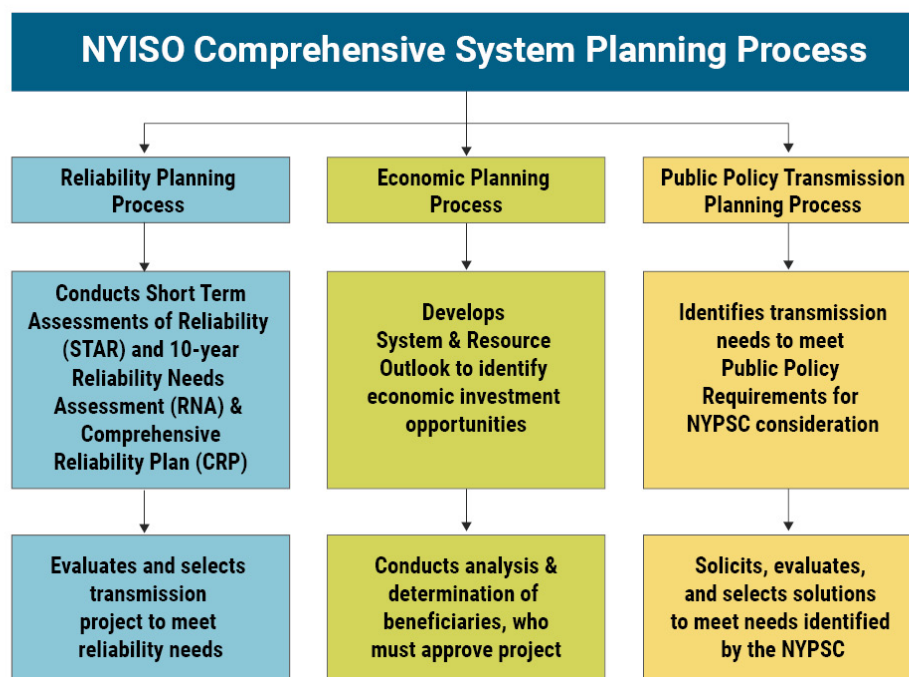

The NYISO develops the RNA in collaboration with stakeholders and interested parties as the first step in the Reliability Planning Process. The RNA assesses the reliability of the New York Bulk Power Transmission Facilities (BPTF) as the foundational study used in the development of the Comprehensive Reliability Plan (CRP). Two major study types—resource adequacy and transmission security—are performed to evaluate the RNA study period (*i.e.*, year 4 through year 10, which correlates to 2028 through 2034).

If the RNA analysis identifies a violation of reliability criteria¹ for BPTFs, the NYISO will report that a Reliability Need exists during the study period and will quantify that need by an amount of compensatory megawatts² (MW) in a location that would mitigate the reliability criteria violation. Following approval of

¹ A condition identified by the NYISO in the RNA as a violation or potential violation of Reliability Criteria as defined by the OATT.

² Compensatory MW represents the concept of “perfect capacity,” meaning the resource that is always available at full capacity.

an RNA that identifies a Reliability Need, the NYISO will begin the second part of the Reliability Planning Process. Initially, the NYISO will update the RNA Base Case in accordance with its procedures and determine whether the Reliability Need is reduced or eliminated. If the identified Reliability Need remains following the NYISO's incorporation of eligible system updates since approval of the RNA, the NYISO will solicit market-based solutions from Developers, regulated backstop solutions from the designated Responsible Transmission Owner(s), and alternative regulated solutions from Other Developers. The solicitation and evaluation of proposed solutions to a Reliability Need, if necessary, will be reported in the CRP.

The CRP details the NYISO's plan for continued reliability of the BPTFs during the study period and identifies additional resources, or combinations of resources, that resolve any identified violation of reliability criteria in the RNA. New or proposed resources included in the CRP may be provided by market-based solutions developed in response to market forces and by the request for solutions. If the market does not adequately respond, reliability will be maintained by either regulated backstop solutions developed by the Responsible Transmission Owners, which are obligated to provide reliable service to their customers, or alternative regulated solutions being developed by Other Developers. To maintain the long-term reliability of the BPTFs, these additional resources must be readily available or in development at the appropriate time to address the identified need.

Proposed solutions that are submitted in response to an identified Reliability Need are evaluated in the development of the CRP. However, the solutions submitted to the NYISO for evaluation in the CRP do not have to be in the same amounts of MW or locations as the compensatory MW reported in the RNA. There are various combinations of resources and transmission upgrades that could meet the needs identified in the RNA. The reconfiguration of transmission facilities and/or modifications to operating protocols identified in the solution phase could result in changes and/or modifications of the needs identified in the RNA.

This report begins by summarizing the state of the New York system, the key findings of the 2023-2032 CRP, and recent reliability rule changes relevant to the RNA. Next, this report highlights the key system trends driving the RNA results. The report continues with a summary of the actionable Base Case results, informational scenario results, and ultimate RNA findings. Detailed assumptions and results are contained in the appendices.

An overview of the Reliability Planning Process is illustrated in Figure 1 and Figure 2 in Appendix B and is described in the Reliability Planning Process Manual.

Background

This section outlines background information to provide context for the RNA results and findings. The first part summarizes the demand and generation characteristics of today’s grid. The next section describes the regulatory policies that are driving changes throughout the study period, including state legislation enacted in 2023 to cease production from NYPA small gas plants downstate. The third part summarizes the key findings of the 2023-2032 CRP; many of which continue to be key findings of this RNA. Finally, there is a description of important changes to relevant reliability rules that are respected in this RNA—most importantly, the unavailability of non-firm gas generation during winter peak conditions.

State of the Grid

This section of the report provides the overview of today’s electric grid in New York, including the statewide demand and resources and the minimum level of capacity procured to serve consumers.

New York’s power grid is dramatically changing how it serves consumers and is evolving to meet the state’s clean energy objectives. The NYISO offers two annual publications—the *Load & Capacity Data Report*³ (Gold Book) and *Power Trends*⁴—that provide independent sources of information and analysis on New York’s electric system.

The New York Control Area (NYCA) is comprised of 11 geographical zones from western New York (Zone A) through Long Island (Zone K). This report refers to these zones to provide locational details regarding system demand, projected resource mixes, and anticipated transmission constraints. A map of the NYCA zones is shown in **Figure 7**.

³ [2024 Load & Capacity Data Report \(Gold Book\)](#)

⁴ [2024 Power Trends](#)

Figure 7: NYCA Load Zones

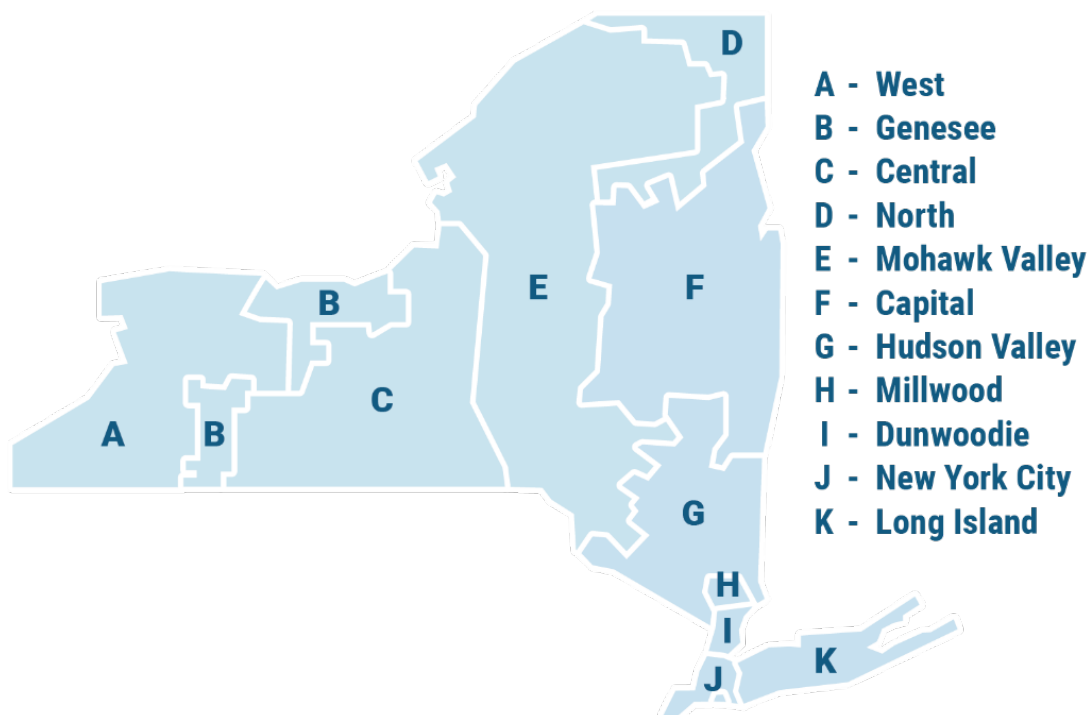

A summary of the current system resources is provided below. **Figure 8** depicts the projected mix of resource capacity that was expected to be available for the 2024 summer capability period, and **Figure 9** provides the energy production by fuel sources in 2023. In 2023, zero-emission resources made up 91% of upstate production, while fossil units located in downstate made up 93% of the production from that region.

Figure 8: Summer Installed Capacity (MW) by Fuel Source – Statewide, Upstate, & Downstate New York: 2024

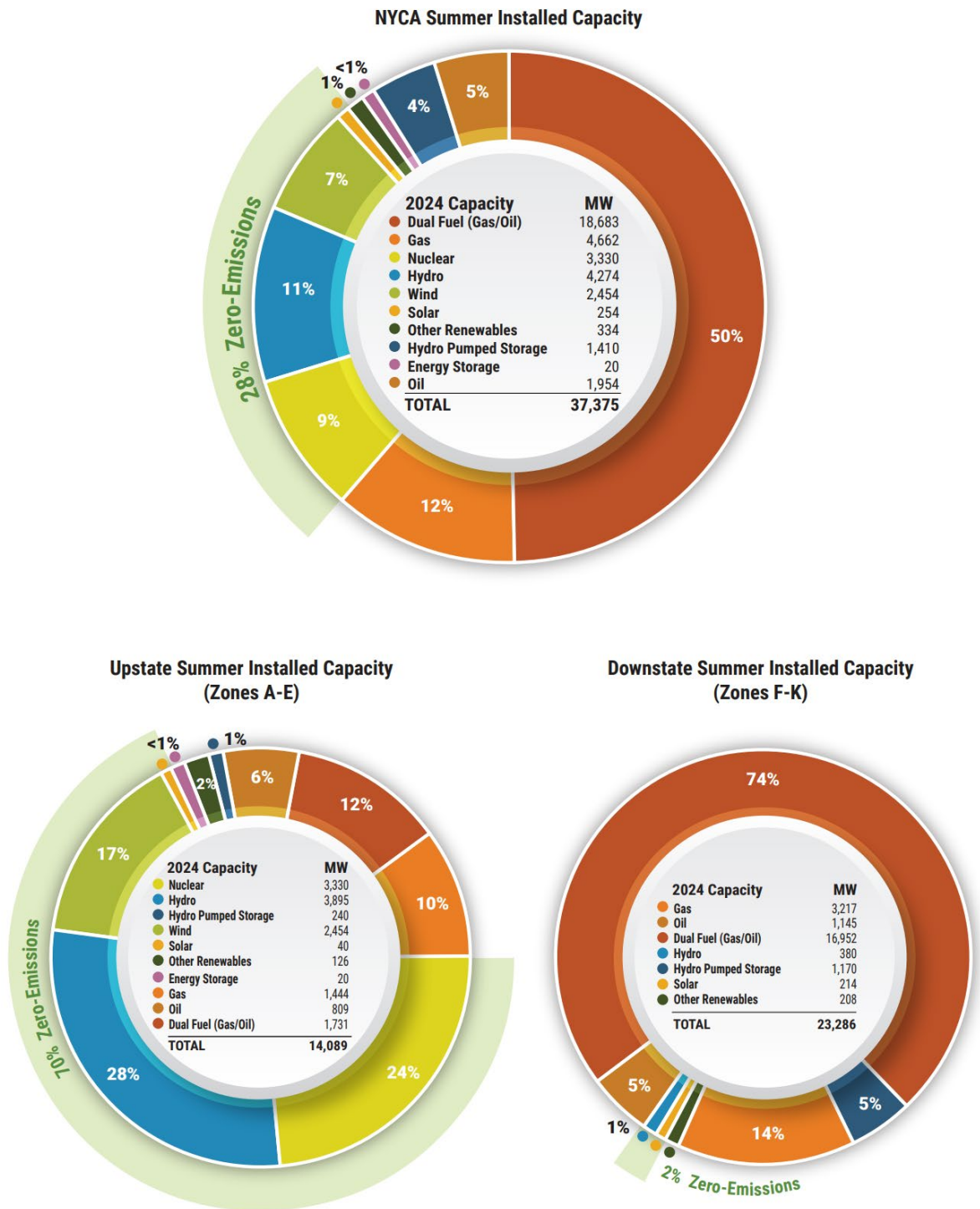
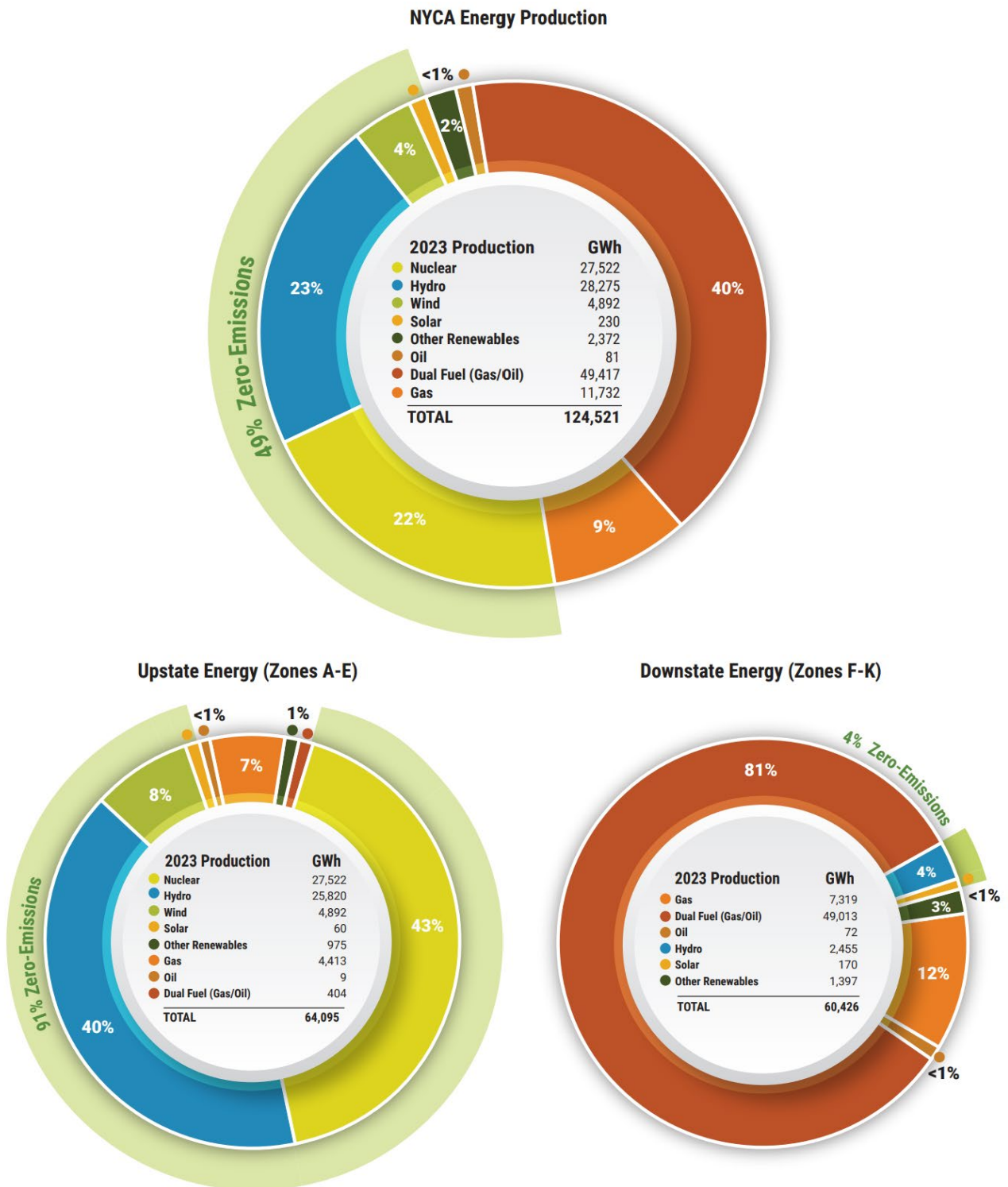

Figure 9: Energy Production by Fuel Source (GWh) – Statewide, Upstate, & Downstate New York: 2023



Total generation resource capability in New York for the summer of 2024 is projected to be 40,461 MW, which includes 37,595 MW of generating capability, 1,281 MW of demand response, and 1,585 MW of net long-term purchases and sales with neighboring control areas.

The New York system’s minimum Installed Reliability Margin (IRM) is established every year by the New York State Reliability Committee (NYSRC). The IRM represents the minimum level of capacity, beyond the forecasted peak demand, which must be procured to serve consumers. The IRM is established every year for each following capability year (May 1 through April 30) and is used to quantify the minimum capacity required to meet the Northeast Power Coordinating Council (NPCC) and NYSRC resource adequacy rules. The NYISO, in assisting the NYSRC, analyzes forecasted demand, supplier performance, transmission capability, and factors such as extreme weather, to measure the grid’s ability to meet reliability requirements. NYSRC has noted in several of its annual *Installed Capacity Requirement Technical Study* reports⁵ that the inclusion of intermittent resources to the grid is a leading factor in establishing higher IRM requirements. The IRM for the May 1, 2024 - April 30, 2025, capability year is 22% of the forecasted NYCA peak load, representing an increase from the 20% established last year. Based on a projected summer 2024 peak demand of 31,541 MW and the IRM, the total installed capacity requirement for the upcoming summer capability period (May 1, 2024, through April 30, 2025) is 38,480 MW.

Figure 10: Statewide Resource Availability: Summer 2024

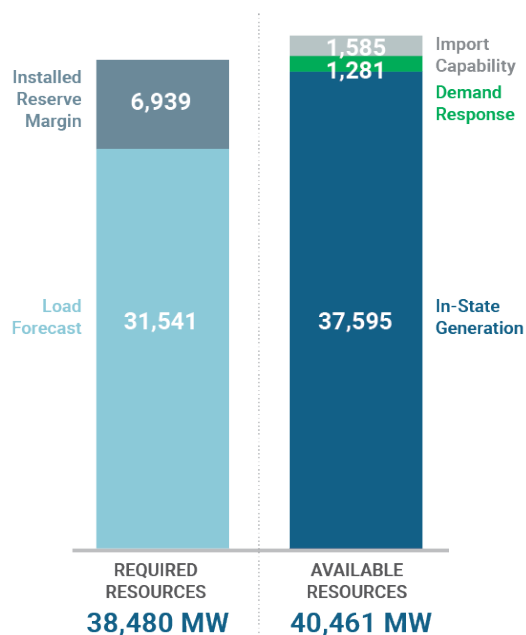

⁵ NYSRC’s IRM Reports: https://www.nysrc.org/NYSRC_NYCA_ICR_Reports.html

Historical average hourly demand versus actual yearly peak demand is shown in the **Figure 11** below.

Figure 11: Historical Average Hourly Demand versus Actual Yearly Summer Peak Demand

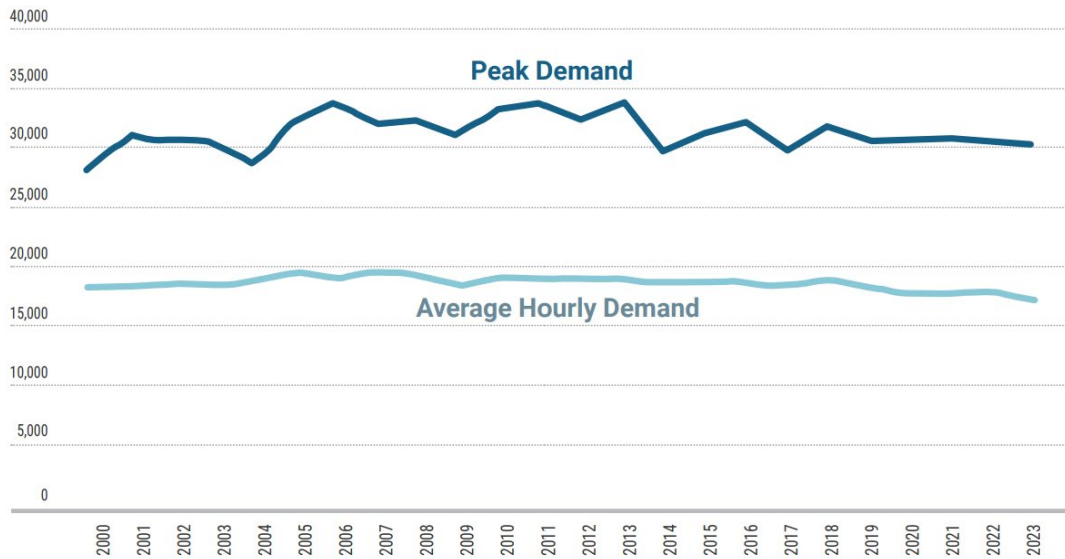

The historical generating capacity fuel mix in New York State from 2000 through 2023 is depicted in the **Figure 12** below.

Figure 12: Historical Generating Capacity Fuel Mix in New York State: 2005-2023

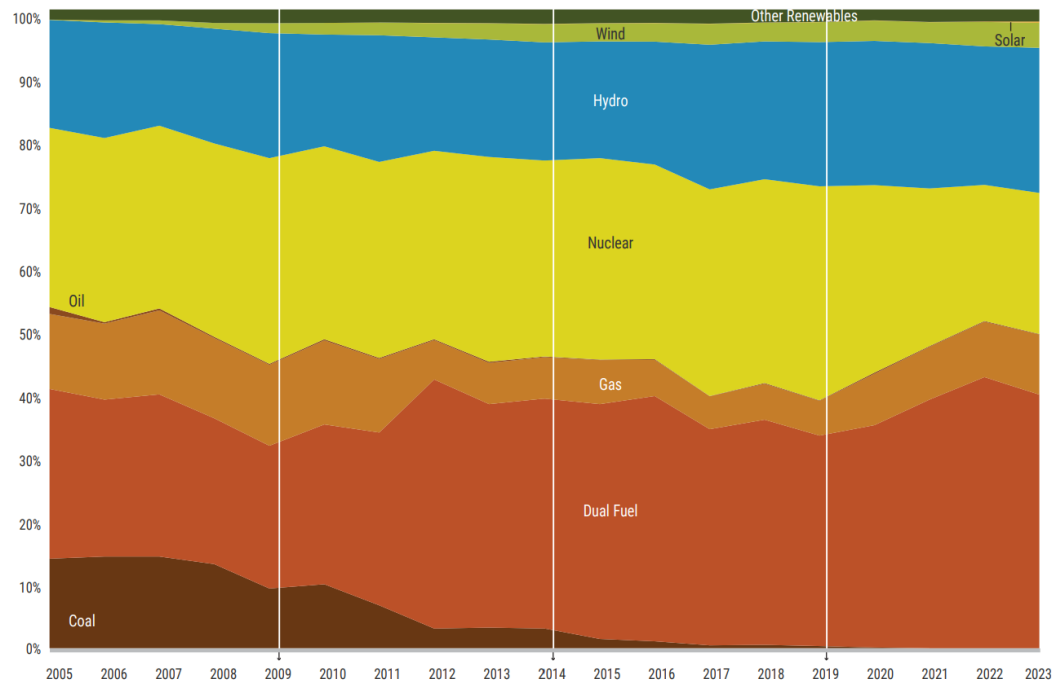

Regulatory Policy Activities Affecting the Reliability Needs Assessment

Increasingly ambitious environmental and energy policies, evolving market rules, technological advancements, and economic factors impact the decisions by market participants and are accelerating the transition in the state’s resource supply mix. During this transition, the pace of both the addition of new resource additions and the retirement of older, higher-emitting resources are projected to exceed historical levels. Changes to demand patterns and the generation fleet driven by federal, state, and local government regulatory programs may impact the operation and reliability of New York’s bulk power system. Compliance with federal and state regulatory initiatives and environmental and permitting requirements may require investment by the owners of New York’s existing thermal power plants in order to continue operation. If the owners of those plants must make significant investments to comply, the increased cost to continue operating could lead to the retirement of these resources needed to maintain the reliability of New York’s bulk power system and, therefore, could necessitate replacement.

Balancing the grid throughout this transition not only requires maintaining sufficient capacity to meet demand but also requires that new resources entering service comparably replace the capabilities and attributes of the resources leaving the system (*e.g.*, fast starting/ramping and dispatchable both up and down, available when and for as long as needed, providing essential reliability services such as voltage and frequency control, support system’s stability during disturbances). Continued dialogue and engagement among Market Participants, policymakers, and the NYISO will be essential to support the planning processes in order to identify the needs and services required to maintain a reliable system during and after this transition period.

The following table summarizes key environmental regulations and energy policies affecting New York.

DEACTIVATIONS AND ADDITIONS SINCE 2019

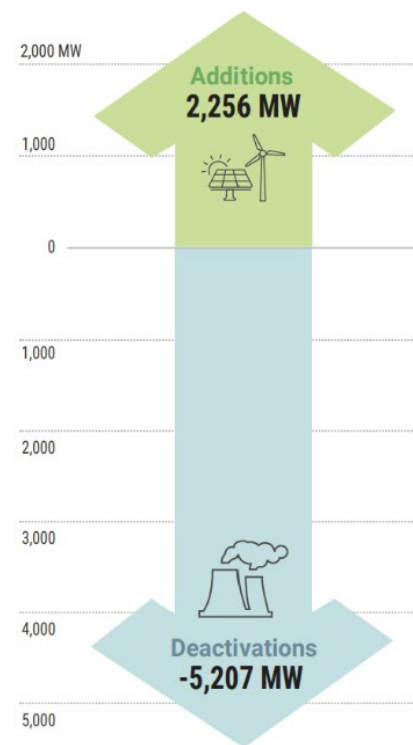

Generator retirements are outpacing additions

Public Policy Initiative	Policy Goal	Policy Implications
Climate Leadership and Community Protection Act (CLCPA)	Overarching goal to reduce New York’s greenhouse gas emissions by 40% of 1990 levels by 2030 and 85% by 2050. Includes, or has driven, many power sector targets, such as: 10,000 MW of distributed solar installed by 2030; 6,000 MW of storage installed by 2030; 70% of load supplied by renewable resources by 2030; 9,000 MW of offshore wind installed by 2035; and 100% of load supplied by zero-emissions resources by 2040.	Transformation of the economy to one powered primarily by electricity as a form of overall emissions reduction. A central pillar in this approach is the power grid, necessitating examination of market structures, planning processes, flexible load, and investment in bulk power system infrastructure. Electrification of building and transportation sectors will increase load substantially and impact when it is in most demand. Identification of future generation resources with potential to achieve policy goals while maintaining electric system reliability will be necessary. Modeling platforms and metrics need to be updated and improved to capture more dynamic, weather dependent systems.
“Peaker Rule:” Ozone Season Oxides of Nitrogen (NOx) Emission Limits for Simple Cycle and Regenerative Combustion Turbines	Reduce ozone-precursor nitrogen oxide emissions associated with New York State-based peaking unit generation during the May-September ozone season. Compliance obligations phased in May 2023 and May 2025. For units identified as needed for reliability, as those in the 2023 Q2 STAR, the rule allows for two or four years of extended operations, subject to conditions specified in the rule.	DEC rule impacts approximately 3,300 MW of peaking unit capacity in New York State, primarily in New York City and Long Island. The NYISO analyzes compliance plans through its Reliability Planning Process (RPP) to determine whether the plans trigger reliability needs that must be addressed with solutions to maintain system reliability. As of May 2023, approximately 1,000 MW of affected peakers deactivated or limited their operations in response to the Peaker Rule.
New York Power Authority Small Gas Power Plant Phase Out	Advance decarbonization date of seven NYPA small natural gas plants to 2030.	Impacts more than 500 MW nameplate capacity in New York City and Long Island. Requires plan to phase out production of electricity from fossil fuels, considering clean replacement resources and impacts on emissions and system reliability. In the 2024 RNA Base Cases, these resources were modeled as unavailable, starting 2031.
Clean Energy Standard (CES)	Predated by the Renewable Portfolio Standard, and now aligned with the CLCPA targets, the CES requires utilities to procure Renewable Energy Credits (RECs) and Zero Emission Credits (ZECs) from eligible generators to support clean electricity content requirements. NYSERDA administers the CES through regular REC solicitation and tracking initiatives while the PSC provides oversight of these programs.	Eligible renewable resources are supported through various Tiers: Tier 1 RECs support new renewable resources, Tier 2 supports pre-2015 resources, Tier 4 supports development of transmission to deliver RECS into New York City, and offshore wind RECs (ORECs) to support the state’s offshore wind targets. ZECs support upstate nuclear generators. RECs and ZECs represent the environmental attributes associated with one MWh of eligible generation.
NYS Accelerated Renewable Energy Growth and Community Benefit Act (AREA)	Provides for an accelerated path for the permitting and construction of renewable energy projects, calls for a comprehensive study to identify cost-effective electric system upgrades, and to file the study with the NYPS. Allows the PSC to designate priority transmission projects. NYSERDA administers a Build Ready program which supports development of brownfield and other industrial sites.	Establishes new transmission investment priorities to facilitate the achievement of state policies, including through the use of NYISO’s Public Policy Planning Process. The PSC oversees a coordinated grid planning process (CGPP) among the utilities to identify local transmission and distribution upgrades throughout the state that prioritize the integration of clean energy resources and electrification initiatives. Recent passage of the RAPID Act streamlines transmission and renewable energy permitting into one Office of Renewable Energy Siting within the PSC.
New York City Residual Oil Elimination	Eliminate combustion of fuel oil numbers 6 and 4 in New York City by 2020 and 2025, respectively. Rule allows additional compliance pathway allowing for direct conversion directly to fuel oil number 2 by 2023.	The rule impacts approximately 3,000 MW of generation in New York City. Affected generators have taken steps to convert their facilities to comply with the law.
New York City Local Law 97	Requires greenhouse gas emissions from covered buildings in NYC be reduced by 40% by 2030 and 80% by 2050. Compliance under the program begins in 2024.	Mandate applies to any building in NYC larger than 25,000 square feet; the law was updated in 2020 to include buildings in which up to 35% of units are rent regulated, starting in 2026. Officials estimate the law would apply to roughly 40,000 of the city’s more than one million buildings, representing nearly 60% of in-city building area. Emissions reduction strategies will be driven by electrification which increase demand for electricity.
Greenhouse Gas Standards and Guidelines for Fossil Fuel-Fired Power Plants	Federal regulations promulgated by the Environmental Protection Agency (EPA) to reduce carbon dioxide emissions from new gas turbine and existing fossil fuel-fired steam turbine generation. The EPA is in the process of developing a comprehensive rulemaking to address existing gas combustion turbine generators.	Requires states submit plans limiting CO ₂ emissions from affected existing steam turbine generators. Oil and gas steam turbine generators must maintain historically achieved emissions rates. Generators may retire or limit operations to be categorized to receive less stringent requirements.

One important regulatory policy for this RNA were provisions included in New York State's *2023-24 Enacted State Budget* that broadened the authority of the New York Power Authority (NYPA) to develop renewable energy and advance NYPA's commitment to phase out their small natural gas power plants.⁶ Under this legislation, NYPA is required to publish a plan by May 2025 to phase out the production of electricity from its seven small natural gas plants (simple-cycle combustion turbines) in New York City and Long Island by December 31, 2030, unless those plants are determined to be necessary for electric system reliability or emergency power service or energy from other sources that may replace energy from NYPA's small plants would result in more than a de minimis net increase in emissions within a disadvantaged community. The units affected by the legislation total 517 MW and are shown in **Figure 13**. NYPA's plan is required to include recommendations and a proposed strategy to replace some or all of the plants with renewable energy systems, if appropriate. The basis for such determinations in NYPA's plan, which are required to be updated at least every two years, must be made publicly available along with the supporting documentation for the determination.

⁶ See New York Public Authorities Law § 1005 (27-c).

Figure 13: NYPA Units Affected by the Legislation

Owner/Operator	Station	Zone	Nameplate (MW)	CRIS (MW) (1)		Capability (MW) (1)		Status Change Date (2)
				Summer	Winter	Summer	Winter	
New York Power Authority	Gowanus 5	J	47.0	45.4	45.4	40.0	40.0	12/31/2030
New York Power Authority	Gowanus 6	J	47.0	46.1	46.1	39.9	39.9	12/31/2030
New York Power Authority	Kent	J	47.0	46.9	46.9	46.0	46.0	12/31/2030
New York Power Authority	Pouch	J	47.0	47.1	47.1	45.4	46.0	12/31/2030
New York Power Authority	Hellgate 1	J	47.0	45.0	45.0	39.9	39.9	12/31/2030
New York Power Authority	Hellgate 2	J	47.0	45.0	45.0	39.6	40.0	12/31/2030
New York Power Authority	Harlem River 1	J	47.0	46.0	46.0	39.9	39.9	12/31/2030
New York Power Authority	Harlem River 2	J	47.0	45.2	45.2	39.6	40.0	12/31/2030
New York Power Authority	Vernon Blvd 2	J	47.0	46.2	46.2	40.0	40.0	12/31/2030
New York Power Authority	Vernon Blvd 3	J	47.0	43.8	43.8	39.9	39.9	12/31/2030
New York Power Authority	Brentwood	K	47.0	47.1	47.1	45.0	46.0	12/31/2030

Notes:

1. MW values are from the 2024 Load and Capacity Data Report.

2. NYPA is required to publish a plan by May 2025 to phase out the production of electricity from its eleven simple cycle natural gas combustion turbines at seven plant sites in New York City and Suffolk County by December 31, 2030 with certain exceptions.

2023-2032 Comprehensive Reliability Plan

The 2023-2032 CRP⁷ provided information on reliability margins and potential risk factors for the evolving grid through 2032. While the NYISO did not identify any actionable reliability needs in the 2022-2023 cycle of the Reliability Planning Process, several risk factors to the reliability of the grid focused on the pace of generation retirements exceeding the pace of resource additions; the upward trend in peak demand coupled with large loads; and the impact of increasing winter peak loads and consideration of non-firm gas unavailability. The key takeaways from the CRP still are relevant to the findings in this RNA and are listed below:

2023-2032 CRP: Reliability Risk Factors - Key Takeaways

- The pace of generation retirements has exceeded the pace of resource additions to date. Should this trend continue, reliability needs will be identified both locationally and statewide. For example, retirement of the NYPA small gas plants without, or prior to, adequate replacement could result in a deficiency in New York City.
- The reliability of the grid is heavily reliant on the timely completion of planned transmission projects, chiefly the Champlain Hudson Power Express (CHPE) project. Without the CHPE project in service or other offsetting changes or solutions, the reliability margins would be deficient for the ten-year planning horizon.
- There is a clear upward trend forecasted in peak demand over the next ten years, with significant uncertainty driven by electrification of heating and transportation coupled with

⁷ CRP Report: <https://www.nyiso.com/documents/20142/2248481/2023-2032-Comprehensive-Reliability-Plan.pdf>

the development of multiple high-electric demand facilities (*e.g.*, microchip fabrication and data centers). As the demand on the grid grows at a rate greater than the build out of generation and transmission, deficiencies could arise within the ten-year planning horizon.

- New York’s current reliance on neighboring systems is expected to continue through the next ten years. Without emergency assistance from neighboring regions, New York would not have adequate resources throughout the next ten years.
- Extreme events, such as heatwaves or storms, pose a threat to grid reliability throughout the planning horizon and could result in deficiencies to serve demand statewide, especially in New York City. This outlook could improve as more resources and transmission are added to New York City.
- The New York statewide grid is projected to become a winter-peaking system in the mid-2030s, primarily driven by electrification of space heating and transportation. The New York statewide grid is reliable for normal weather in the winter for through 2032, but deficiencies would arise as early as winter 2027-2028 for an extreme 1-in-100-year winter cold snap coupled with a shortage of gas fuel supply. Additional deactivations of dual-fuel generation beyond what is planned will exacerbate the winter reliability risk.
- Planning for the more extreme system conditions of heatwaves, cold snaps, and fuel availability is currently beyond established design criteria. However, several reliability organizations are investigating whether applicable reliability rules and design criteria should be revised to account for these events.

Updated Reliability Criteria and Compliance Activities

The overall purpose of the standards and criteria established by the North American Electric Reliability Council (NERC), NPCC, and NYSRC is to ensure reliability. The NYISO has proactively worked with the NYSRC to develop new rules and criteria to address the reliability risks around generation fuel availability and fuel delivery systems observed in prior cycles of the Reliability Planning Process. As the New York statewide grid is expected to become winter peaking in the mid-2030s, it is expected that the gas supply to electric generation plants will be strained beyond what has been observed historically. As such, the language defining considerations for identifying the credible combinations of conditions evaluated in planning was adjusted to include considerations for generation availability that include limitations related to weather conditions (*i.e.*, non-firm gas generation unavailability during winter peak). The NYISO also collaborated with the NYSRC in the development of a new design criteria contingency to capture the impact of the loss of fossil fuel to a plant for a common-mode failure of the fuel delivery system.

The RNA and CRP, as well as the quarterly Short-Term Assessments of Reliability (STARs), are the most forward-facing reliability planning that the NYISO engages in with Market Participants and policymakers. However, the NYISO performs various other planning obligations related to the reliability of

the New York system to comply with requirements of NERC, NPCC, and NYSRC. The periodicity and scope of these requirements varies among the standards and reliability organizations. Additional details regarding the NYISO's planning obligations are provided in Appendix I.

Electric Grid Trends

The Background Section set the stage for where the electric grid is today and the regulatory policies that will shape all aspects of the future electric grid. This section highlights the key trends that will affect the reliability of the grid. Given the expected pace and novelty of the changes that are expected to occur over the next ten years, there is inherently more uncertainty in the assumptions and modeling data for this RNA than past RNAs. However, this RNA and future reliability studies will continue to account for and refine the assumptions and modeling data necessary to plan for the reliability of the New York system.

The NYISO has established procedures and a schedule for the collection and submission of data and for the preparation of the models used in the RNA. The 2024 RNA Base Case was developed in accordance with NYISO procedures using projections using forecasts for demand, resource addition and deactivation, and transmission facility expansion. The NYISO reviewed the assumptions underlying the RNA in conjunction with Market Participants at various meetings of the ESPWG and/or TPAS and are shown in Appendix C and Appendix D.

Demand Growth and Uncertainty

The RNA utilizes forecasts from the Gold Book, which contains multiple forecast scenarios, to perform the analyses. This 2024 RNA uses the baseline forecast, the lower demand scenario forecast, and the higher demand scenario forecast from the 2024 Gold Book. All forecasts account for economic growth and other drivers. Critical components of the demand forecasts include, but are not limited to:

Major Factors Impacting Demand Forecast	
Increasing Factors	Decreasing Factors
Building electrification	Behind-the-meter solar generation
Electric vehicles	Energy efficiency
Large load projects	

The use of demand scenarios has become increasingly important as the nature of the load growth significantly evolves from historic patterns. In prior years, the forecasted load change has generally been due to broad trends in economic growth with narrower bands of uncertainty. The current load growth projections, however, are tightly tied to specific state policies contributing to the electrification of building conditioning and transportation, as well as the increase in the interconnection of discrete large loads. The timing and magnitude of these drivers are less certain. As a result, the NYISO considers a range of forecasts from the 2024 Gold Book.

The lower demand scenario represents a lower bound on forecast growth, including slower economic growth and rate of electrification. Efficient deployment of behind-the-meter generation and energy efficiency measures could also further reduce the net demand served by the bulk electric system. The higher demand scenario represents a higher bound on forecast growth, including faster economic growth and electrification sufficient to meet state policy targets, and includes additional large load growth not included in the baseline forecast.

Figure 14: 30-Year NYCA Summer and Winter Peak Forecasts

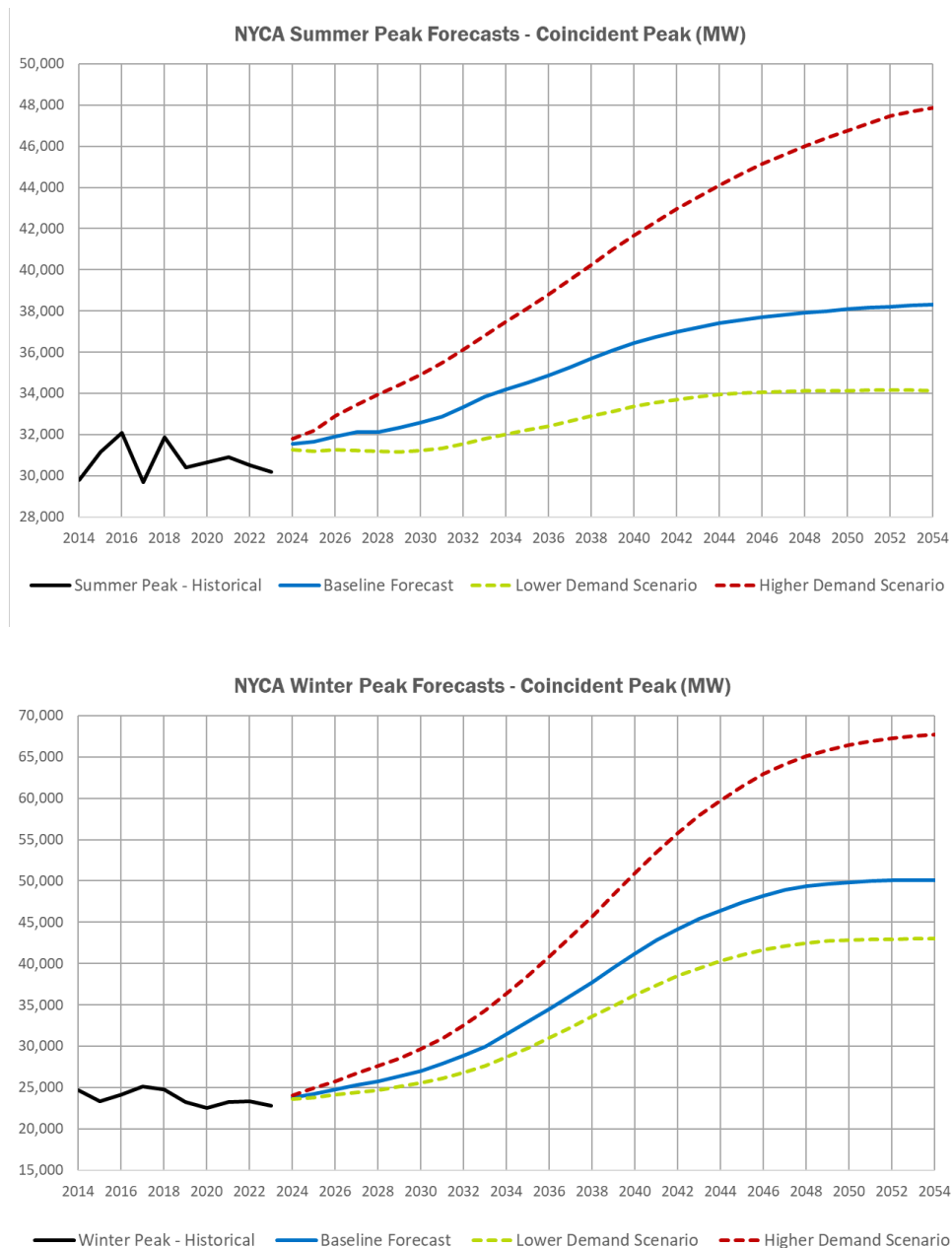

The figures below separate out each component of the projected load forecasts and quantify them either as an increase or decrease in the projected demand. For example, Behind-the-Meter (BTM) solar resources (yellow) can be seen as a decrease in net demand, while electric vehicles (purple) can be seen as an increase in net demand. All of the forecast scenarios project increased load over time. Notably, electrification and large loads have a significant impact on the projected increase in the forecasts. However, the scale of these projected increases due to the applicable component vary by forecast.⁸

Figure 15: NYCA Baseline Summer & Winter Peak Forecast Impacts - MW

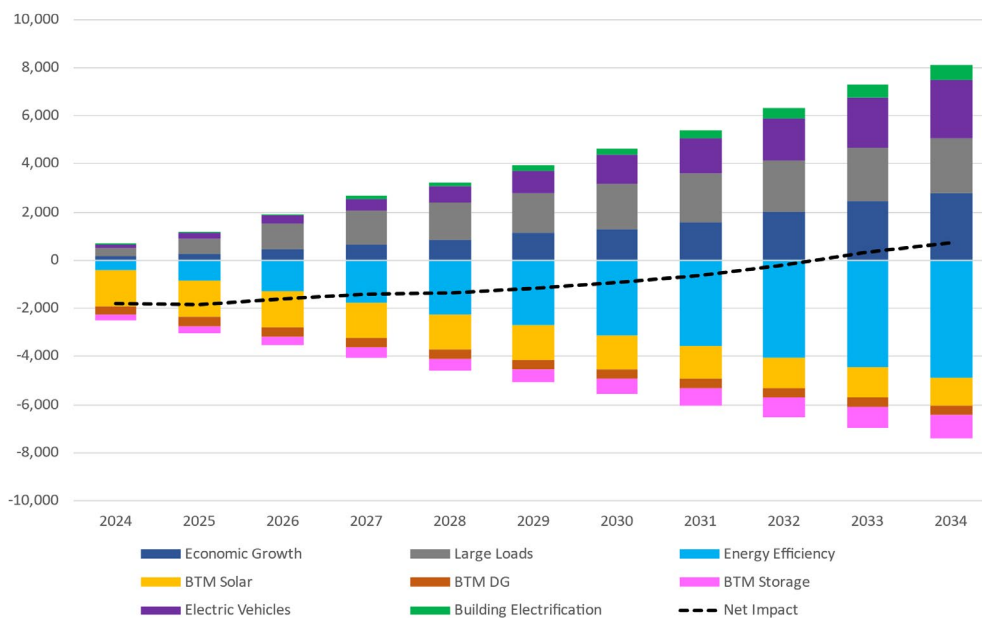

⁸ Additional electrification beyond what is included in these forecasts would increase demand even further. For example, electrification of the Con Edison steam system to comply with policy mandates would lead to a further increase in projected demand. See generally, [The Evolution and Future of the Con Edison Steam System](#).

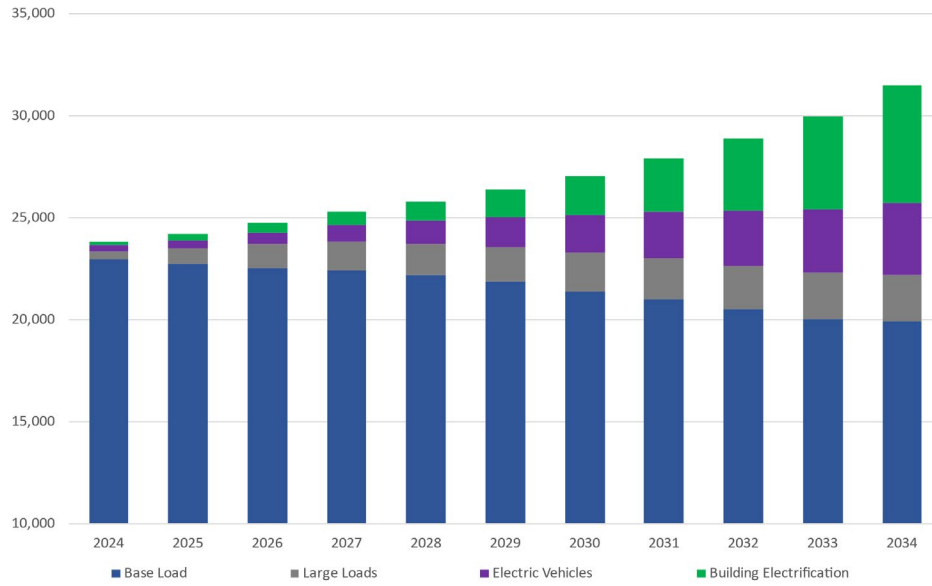

Note: Base load growth includes reductions due to BTM distributed generation, BTM energy storage, energy efficiency, and temperature trends.

Figure 16: Higher Demand Scenario Peak Forecast Impacts

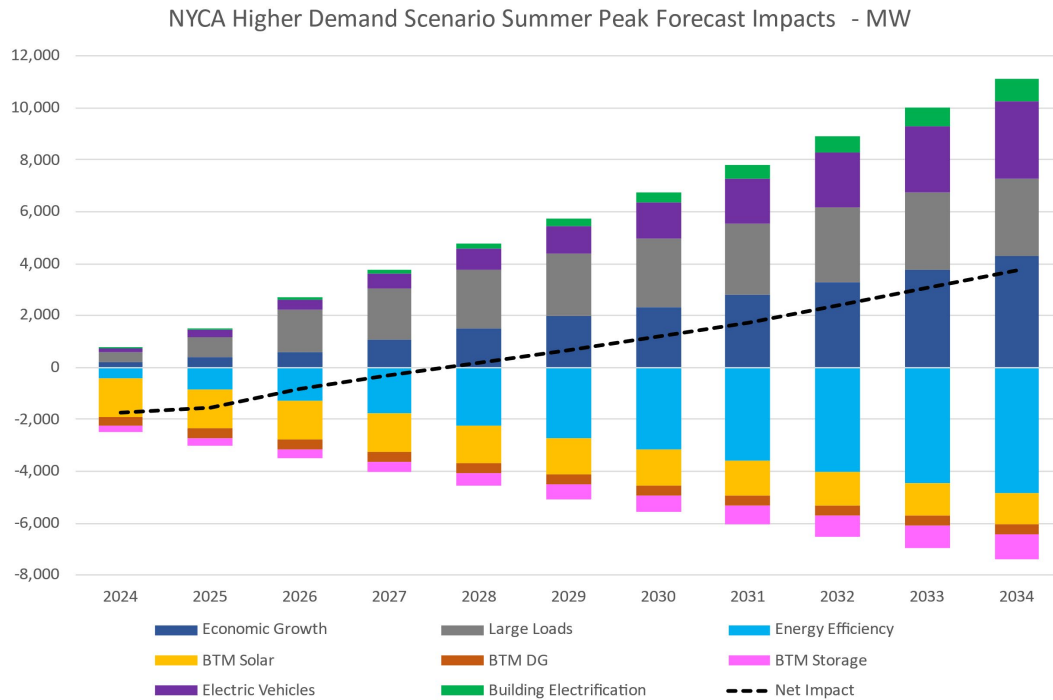

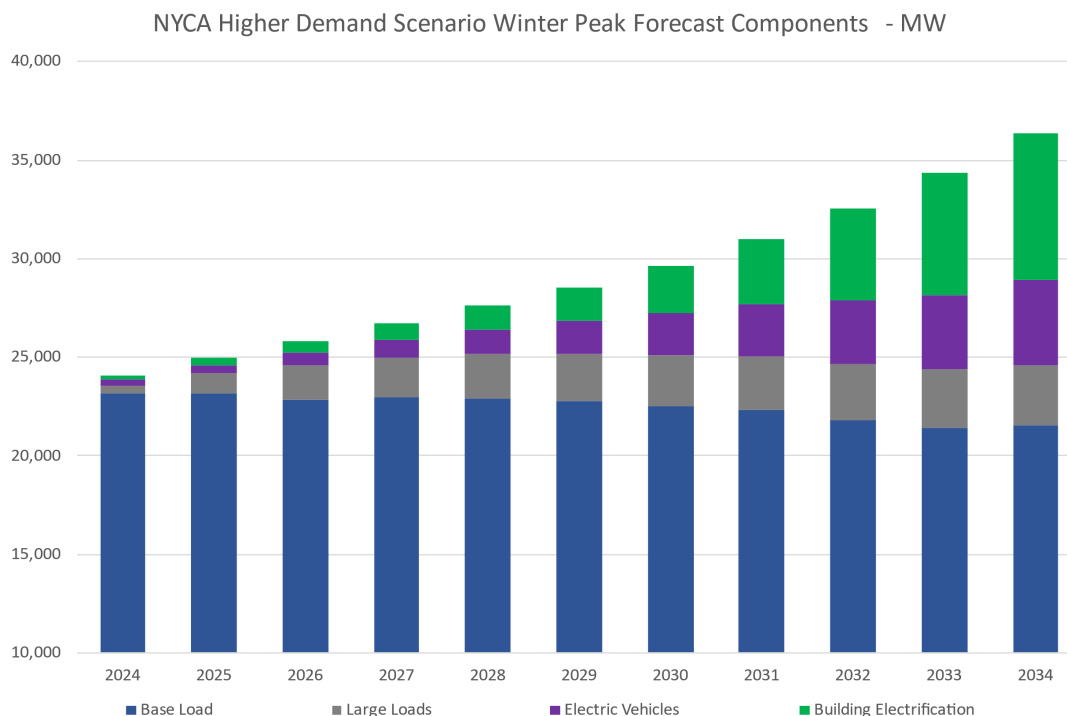

Note: Base load growth includes reductions due to BTM distributed generation, BTM energy storage, energy efficiency, and temperature trends.

Development of Large Loads

Due to economic development and in anticipation of electrification efforts over the next two decades, numerous new large loads are expected to interconnect to the New York system. These large loads are primarily proposed and expected to be concentrated in upstate New York. Most of these new loads consist of manufacturing facilities and data centers, as well as hydrogen production operations (*i.e.*, electrolysis).

While only a few large load projects have been connected to the New York system in the past decade, the pace of new load interconnection requests⁹ in New York has grown dramatically over the past several years. The NYISO currently has 19 projects requesting to interconnect for a combined total of over 3,000 MW of load. It is projected that over the next decade numerous additional manufacturing and data center projects will be constructed and begin consuming relatively large amounts of electricity. As a result, the forecasts project the impacts of these future large load projects. The large load projects included in the forecasts vary by scenario,

⁹ Load interconnections that are subject to the NYISO's procedures include requests that are either (a) greater than 10 MW connecting a voltage level of 115 kV or above or (b) 80 MW or more connecting at a voltage level below 115 kV. Loads that do not meet one of the aforementioned criteria are handled through the Transmission Owner's processes.

with the higher demand forecast including more than the baseline forecast. **Figure 17** highlights the majority of large loads with active requests in the NYISO Interconnection Queue (the figure does not include some of the more-recent load interconnection projects).

Figure 17: Large Load Projects in the NYISO Interconnection Queue

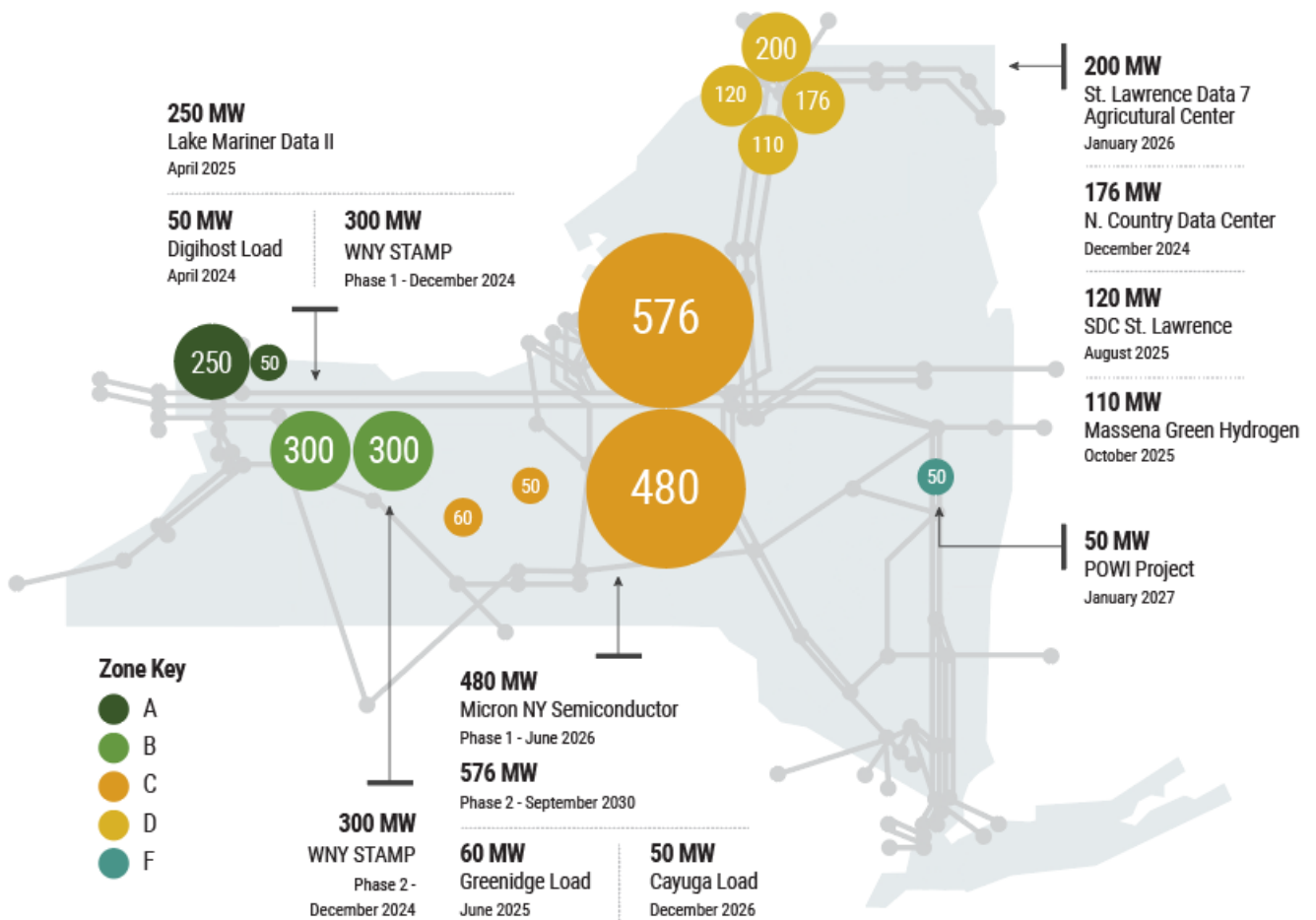

The table below shows the large loads assumed in the baseline and higher demand forecasts.

Figure 18: RNA Large Load Forecast Assumptions

Year	Large Load Energy Forecasts (GWh)		Large Load Demand Forecasts (MW)	
	Baseline Large Loads	Higher Demand Large Loads	Baseline Large Loads	Higher Demand Large Loads
2024	2,860	2,860	368	368
2026	8,670	11,830	1,091	1,619
2028	11,770	17,420	1,529	2,257
2030	14,330	19,980	1,894	2,622
2032	15,940	21,590	2,124	2,852
2034	16,950	22,600	2,268	2,996

The trend of rapid large load additions appeared within the past few years and is observed across the country with regional variations in the speed and types of loads. While the RNA includes these large loads in the Base Case, there could be differences in the actual large loads that ultimately interconnect to the system.

The impact of large load assumptions on the forecast is significant. **Figure 19** below show the baseline forecast with and without large load growth. The timing and level of large load interconnections will have major impacts on future load growth and system risk.

Figure 19: Large Load Impact on NYCA Baseline Load Forecast

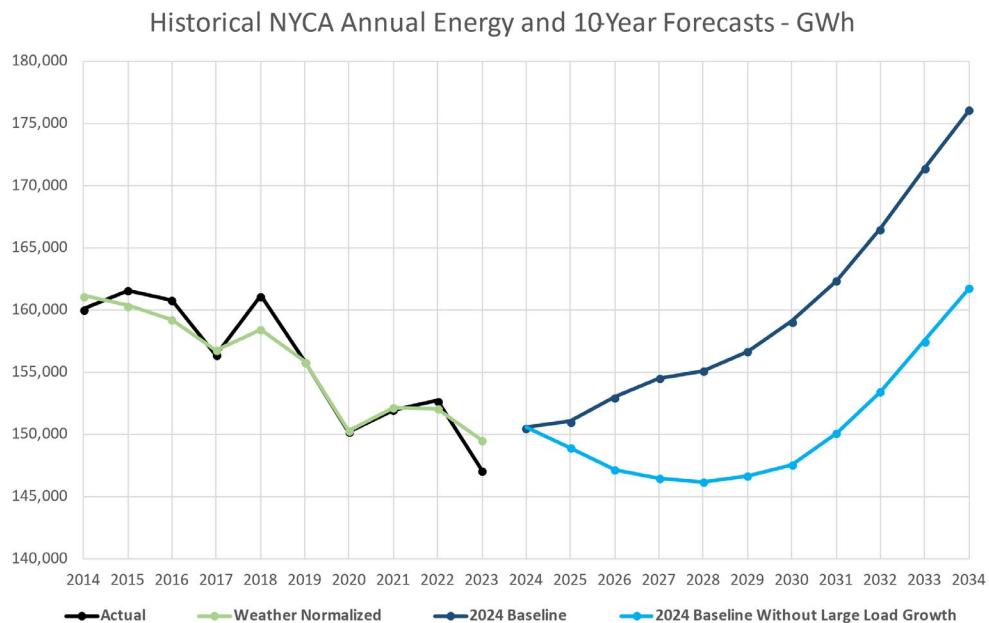

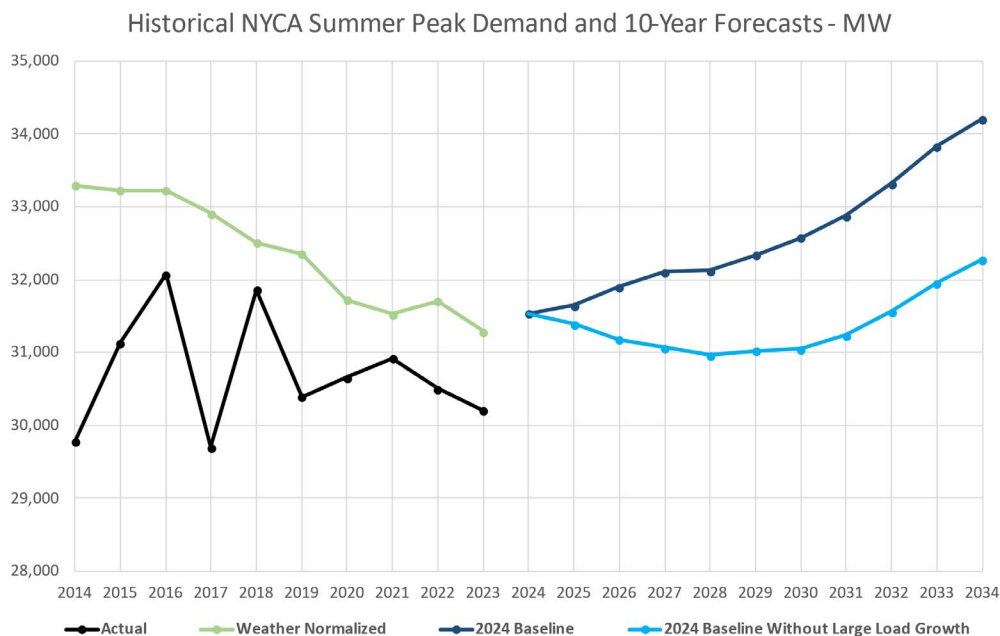

Generation capacity in New York is secured to ensure that demand can be met at all times, including for new large loads added to the system. Generation capacity above and beyond the maximum load is necessary to ensure reliability and resource availability. This means that new large load interconnections will increase the requirement for generation capacity to a value greater than the load itself. This will have a significant impact on the need for new generating capacity.

Some large load projects, however, do not always require the entire amount of the load for all hours or during peak system demand. The ability for large loads to be flexible in their usage is an extremely important consideration, particularly during times of peak system demand. Enabling load flexibility, or the ability to move load from times of greater system demand to times with lower demand or higher renewable energy production, for large loads added to the system can significantly reduce the generation capacity buildout required.

One key assumption in this RNA is that cryptocurrency mining and hydrogen production large loads will be flexible during system peak demand conditions. This assumption, based on communications with load developers and recent operating experience, results in up to approximately 1,200 MW of large load reduction during the winter and summer peak periods.

Given how recent the trend of large load development is, the speed and the scale of them coming to the service, as well as their operating characteristics, requires continuous monitoring as they progress and eventually start drawing power from the system. The NYISO will continue to coordinate with load developers and TOs.

Resource Additions and Removals

The RNA Base Case inclusion rules set forth in the Reliability Planning Process Manual establish a relatively high bar for the NYISO to include resource additions and removals in the Base Case. Resource additions must meet certain interconnection, financing, procurement, and/or construction milestones to be included in the Base Case. A total of approximately 2,650 MW of resources additions are included in the Base Case, which are comprised of approximately 860 MW of solar, 40 MW of battery storage, and 1,750 MW of offshore wind.

While the Base Case includes 2,650 MW of resource additions, this does not reflect the total amount of projects in the pipeline, which are at various stages of development. Because of this high bar to be included in the Base Case, many of the resources that are currently under development to meet New York's decarbonization goals have not reached the necessary milestones to be included and, therefore, are not reflected.

Approximately 1,250 MW of existing generation has been removed from the RNA Base Case based on the generator deactivation rules set forth in the Reliability Planning Process Manual. This includes 750 MW of generation removed because the generator is (1) in a deactivation state, (2) operationally impacted by the DEC Peaker Rule, or (3) one of the NYPA small gas plants (totaling 517 MW) that is assumed retired at the end of 2030.

While the nameplate size of resource and import additions is greater than the nameplate size of the removals, the operating characteristics of the added resources is very different than those of the removed resources. In particular, the winter reliability risks described in the next section are exacerbated by the fact the solar, wind, and external transmission additions do not provide as much energy and capacity during the winter peak hours as the fossil generation that is being removed. Furthermore, Quebec is a winter peaking area and the planned exports to New York during winter decrease significantly compared to prior years.

Figure 20 below summarizes the changes in resource additions, removals, and net imports (*i.e.*, CHPE project) compared to the changes in summer and winter peak demand throughout the 10-year study period. **Figure 21** summarizes the nameplate capacity of existing and additional renewable resources included in the RNA Base Case for year 10. Further details on additions, removals, and net imports can be found in Figures 8 through 11 in Appendix D.

Figure 20: Base Case Additions, Removals, Net Imports, and Load

NYCA, MW								
Year (1)	Additions (2)	Removals (3)	Summer Peak			Winter Peak		
			Net Imports	Summer Baseline Coincident Peak	Large Loads Demand (4)	Net Imports	Winter Baseline Coincident Peak	Large Loads Demand (4)
2024	200	171	1,844	31,541	368	735	23,800	372
2025	825	760	1,844	31,650	630	735	24,210	783
2026	1,829	760	3,094	31,900	1,091	735	24,730	1,201
2027	2,645	760	3,094	32,110	1,409	735	25,270	1,409
2028	2,645	760	3,094	32,130	1,529	735	25,760	1,529
2029	2,645	760	3,094	32,340	1,683	735	26,350	1,683
2030	2,645	760	3,094	32,580	1,894	735	27,020	1,894
2031	2,645	1,216	3,094	32,880	2,009	735	27,900	2,009
2032	2,645	1,216	3,094	33,320	2,124	735	28,850	2,124
2033	2,645	1,216	3,094	33,830	2,239	735	29,950	2,239
2034	2,645	1,216	3,094	34,210	2,268	735	31,480	2,268

Notes:

1. For Winter Peak, represents the winter beginning with the listed year (e.g. Winter 2034 is Winter 2034-35).
2. Represents running total of MW based on the Nameplate Rating for the first summer peak period following the addition.
3. Represents running total of MW based on the Summer Capability (DMNC) for the first summer peak period following removal.
4. Large loads are included in the Baseline Coincident Peak load forecasts.

Figure 21: Existing and Additional Renewable Fuel Mix by 2034 - MW

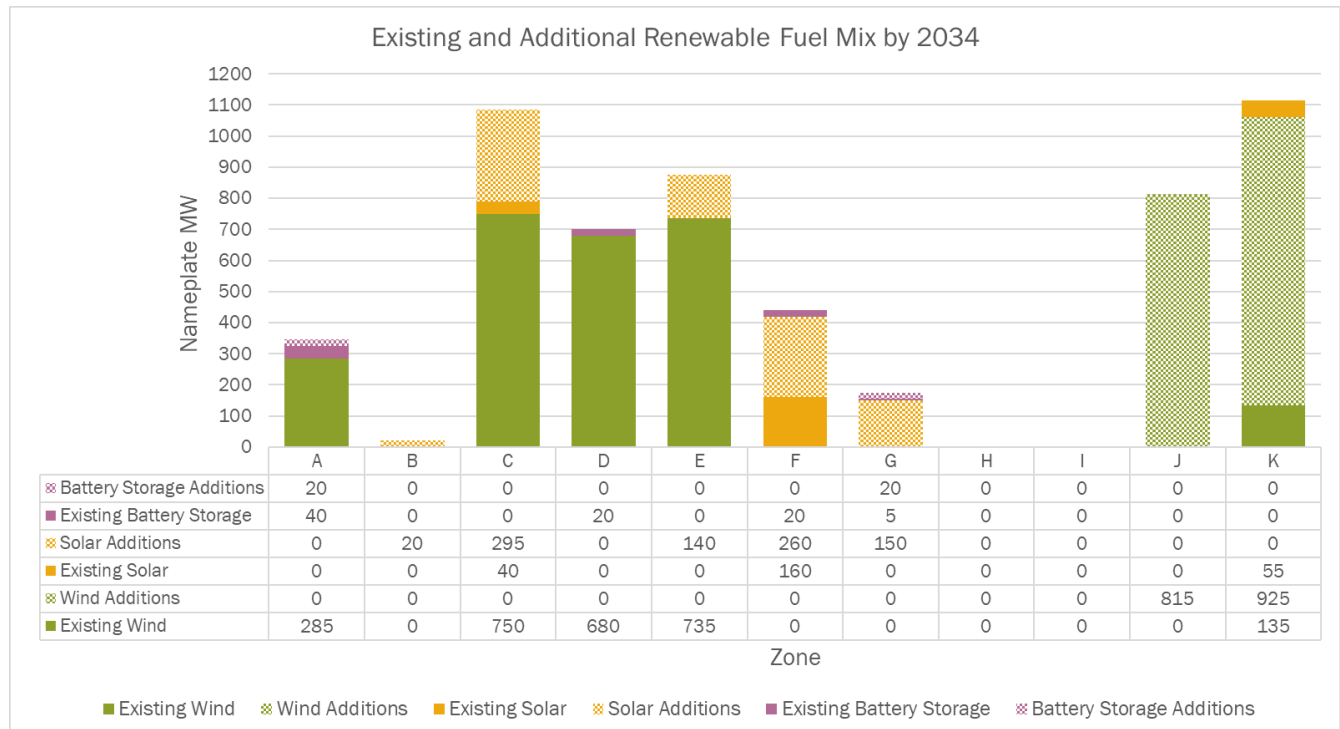

Gas Unavailability

As New York becomes a winter-peaking system, the gas supply to electric generation plants is expected to be strained. On the coldest days, the natural gas distribution companies must serve residential heating first and, when there is insufficient gas supply, limit the fuel available to generators without firm contracts. These coldest days also correspond to peak winter demand periods when the gas generation fleet is needed the most. As described in Background section, NYSRC recently revised its reliability rules to require the NYISO to plan for credible system conditions that model anticipated winter peak load and the unavailability of generation with non-firm gas contracts. Accounting for this new reliability rule in the RNA results in the assumed unavailability of approximately 6,400 MW of generation, primarily in eastern New York, under expected winter weather peak demand conditions (statewide average 14°F). The specific modeling of gas unavailability in the RNA Base Case analysis is described below:

- **Transmission Security:** In the winter peak cases, generation fueled by non-firm gas is modeled as out-of-service while non-firm dual-fuel units are modeled at the generation capability when running on their alternative fuel source.
- **Resource Adequacy:** In the winter months, the reduced capability described above is triggered when the demand exceeds that year's baseline winter coincident peak forecast.

Actionable RNA Results

The Reliability Planning Process is conducted under a defined set of rules that are aligned and coordinated with the related planning activities of NERC, NPCC, and NYSRC. For the 2024 RNA, the NYISO performed a comprehensive assessment of the reliability of the BPTFs using the RNA Base Case to identify any violations of Reliability Criteria. System reliability is determined by resource adequacy and transmission security analyses, described below, according to Reliability Criteria established by NERC, NPCC, and NYSRC:

- **Resource Adequacy:** The ability of the electric systems to supply the aggregate electrical demand and energy requirements of their customers at all times, taking into account scheduled and reasonably expected unscheduled outages of system elements.
- **Transmission Security:** The ability of the power system to withstand disturbances, such as electric short circuits or unanticipated loss of system elements and continue to supply and deliver electricity. Transmission security is assessed deterministically with potential disturbances being applied without concern for the likelihood of the disturbance in the assessment. Transmission security analysis is comprised of the following assessments:
 - **Steady-State Thermal** – Determines if the power flow on branch or transformer is higher than the applicable rating.
 - **Steady-State Voltage** – Determines if the voltage level at a bus in the system is within the acceptable range of voltage limits.
 - **Transient Stability** – Determines the ability of the system to maintain a state of equilibrium during and following disturbances.
 - **Short Circuit** – Determines if the system can clear faulted facilities reliably under short circuit conditions.
 - **Transmission Security Margin** – Determines the ability to meet load plus losses against the generation, interchanges, and temperature-based generation de-rates (total resources) for a certain locality within NYCA. Transmission security margins identify plausible changes in conditions or assumptions that might adversely impact the reliability of the system.
- **Statewide System Margin:** Measure of the amount of generation and net imports available to supply firm load with the bulk power transmission system within applicable normal ratings and limits (i.e., Normal Transfer Criteria) while maintaining 10-minute operating reserves.

To gauge the impact of large loads and potential reliability risks, the analyses were first run without reflecting the flexibility of cryptocurrency mining and hydrogen production loads. If necessary to resolve constraints during peak load conditions, up to 1,200 MW of large load consumption was reduced to represent the flexibility of cryptocurrency mining and hydrogen production loads. If any violations of Reliability Criteria are identified, the NYISO identifies a Reliability Need. The most significant results from the RNA Base Case evaluation are described below. Further detail on the methodology used in the assessment and the results can be found in Appendix E and Appendix F.

Resource Adequacy Results

The NYISO conducts resource adequacy analysis using the GE-MARS software package. GE-MARS performs probabilistic simulations of outages of capacity and select transmission resources. In determining the reliability of a system, there are several types of randomly occurring events that are taken into consideration. Among these are the forced outages of generation and transmission and deviations from the forecasted loads. As a result, the program employs a sequential Monte Carlo simulation method and calculates expected values of reliability indices, such as loss of load expectation (LOLE in event-days/year), loss of load hours (LOLH), and expected unserved energy (EUE). Additional modeling details (*e.g.*, assumptions matrix, model description) and links to various stakeholders' presentations are included in Appendix E.

The planning model for this RNA reflects several important changes to account for winter uncertainty and large load flexibility:

- **On the resource side**, unavailability of non-firm gas unavailability was modeled during winter peak conditions;
- **On the demand side**, a load forecast growing (through study years) uncertainty was modeled for winter to account for electrification; and
- **On the demand side**, approximately 1,200 MW of cryptocurrency mining and hydrogen producing large loads were modeled to account for their flexibility during peak conditions.

Resource Adequacy Base Case Results

LOLE is generally defined as the expected (weighted average) number of days in a given period (*e.g.*, one study year) when for at least one hour from that day the hourly demand is projected to exceed the zonal resources (event day). Within a day, if the zonal demand exceeds the resources in at least one hour of that day, this will be counted as one event-day. The criterion is that the LOLE shall not exceed one day in 10 years, or $LOLE < 0.1$ days/year.

The NYCA LOLE results for the 2024 RNA Base Case with and without the large load flexibility are presented below in **Figure 22**. The resource adequacy studies show that the annual NYCA LOLE would be below the 0.1 event-days/year criterion for each study year. There is a sharp increase in LOLE in the outer years with the LOLE just below criterion for 2034. For information, the LOLE results are also shown without large load flexibility, which would result in an LOLE above the criterion in 2034. As reflected in **Figure 23**, the increase in LOLE is mainly due to the winter risks reflected in the Base Case, such as the non-firm gas unavailability and growth in winter demand forecast.

Figure 22: NYCA Resource Adequacy LOLE Results

Study Year	NYCA Annual LOLE (event-days/year)	
	Base Case without Large Loads Flexibility	Base Case with Large Loads Flexibility
2025	0.031	0.024
2026	0.010	0.006
2027	0.009	0.006
2028	0.007	0.005
2029	0.009	0.006
2030	0.004	0.001
2031	0.011	0.004
2032	0.030	0.010
2033	0.080	0.022
2034	0.289	0.094

Figure 23: NYCA Resource Adequacy Annual, Summer, Winter LOLE Results

Study Year Summer	Base Case with Large Loads Flexibility NYCA LOLE (event-days/year)			Study Year Winter
	Annual	Summer	Winter	
2025	0.024	0.024	0.000	2024-25
2026	0.006	0.006	0.000	2025-26
2027	0.006	0.006	0.000	2026-27
2028	0.005	0.005	0.000	2027-28
2029	0.006	0.006	0.000	2028-29
2030	0.001	0.001	0.000	2029-30
2031	0.004	0.003	0.000	2030-31
2032	0.010	0.009	0.001	2031-32
2033	0.022	0.012	0.010	2032-33
2034	0.094	0.017	0.076	2033-34

Note: 2024 RNA Study Years are year 4 (2028) through year 10 (2034). Years 1 through 3 are for information.

LOLE accounts for events but does not account for the magnitude (MW) or duration (hours) of a deficit. Therefore, the NYISO calculates two additional reliability indices for informational purposes—LOLH (in event-hours/year) and EUE (in MWh/year).¹⁰

LOLH is generally defined as the expected number of hours per period (*e.g.*, one study year) when a system’s hourly demand is projected to exceed the zonal resources (event-hour). If the zonal demand exceeds the resources within an hour, this will be counted as one event-hour.

EUE, also referred to as loss of energy expectation (LOEE), is generally defined as the expected energy (MWh) per period (*e.g.*, one study year) when the summation of the system’s hourly demand is projected to exceed the zonal resources. Within an hour, if the zonal demand exceeds the resources, this deficit will be counted toward the system’s EUE.

While the resource adequacy reliability criterion of 0.1 days/year established by NPCC and NYSRC is compared with the loss of load expectation (LOLE in event-days/year) calculation, there currently is no criterion for determining a reliable system based on the LOLH and EUE reliability indices. **Figure 24** shows that LOLH and EUE rise sharply at the end of the study period along with LOLE, reaching 0.25 hours/year and 148 MWh/year, respectively, by 2034.

Figure 24: NYCA Resource Adequacy Results with Additional Reliability Indices

Study Year	LOLE (event-days/year)	LOLH (event-hrs/year)	EUE (MWh/year)
2025	0.024	0.064	21.9
2026	0.006	0.017	3.5
2027	0.006	0.017	3.3
2028	0.005	0.012	1.7
2029	0.006	0.016	2.6
2030	0.001	0.002	0.5
2031	0.004	0.007	2.3
2032	0.010	0.025	9.4
2033	0.022	0.053	22.8
2034	0.094	0.251	148.1

¹⁰ NYSRC’s “Resource Adequacy Metrics and their Application” is available at: [https://www.nysrc.org/PDF/Reports/Resource%20Adequacy%20Metric%20Report%20Final%204-20-2020\[6431\].pdf](https://www.nysrc.org/PDF/Reports/Resource%20Adequacy%20Metric%20Report%20Final%204-20-2020[6431].pdf).

Zonal Resource Adequacy Margins (ZRAM)

Resource adequacy simulations were performed on the RNA Base Case to determine the zonal resource adequacy margin (ZRAM) for each NYCA zone during the study period. ZRAM is the amount of “perfect capacity” in each zone (one zone at the time) that could be removed before the NYCA LOLE reaches 0.1 event-days/year. The ZRAM analysis provides another relative measure of the risks of how close the system is from not having adequate resources to reliably serve load, without attributing to a specific driver, such as generation unavailability or forecast increase. In the context of resource adequacy analysis, “perfect capacity” is capacity that is not derated (*e.g.*, not impacted by ambient temperature variation or unit unavailability); not subject to energy durations limitations (*i.e.*, available at maximum capacity every hour of the study year); and not assessed for transmission security or interface impacts.

The results in **Figure 25** and **Figure 26** show eroding margins in the outer years. 2034 is only 50 MW away from violating the LOLE criterion. Unlike the earlier years, the 50 MW ZRAM is consistent across the NYCA zones in 2034 and, therefore, signifies a statewide risk for potential resource shortages that are not driven by internal NYCA constraints.

Figure 25: Zonal Resource Adequacy Margins - ZRAM (MW)

Study Year	Base Case LOLE event-days/year	Zone A MW	Zone B MW	Zone C MW	Zone D MW	Zone E MW	Zone F MW	Zone G MW	Zone H MW	Zone I MW	Zone J MW	Zone K MW
2025	0.024	-1500	-1500	-2200	-1500	-2200	-2200	-2200	-1600	-1600	-1300	-500
2026	0.006	-1600	-1600	-3400	-1600	-3400	-3400	-3400	-2700	-2700	-2200	-700
2027	0.006	-1700	-1700	-3600	-1900	-3600	-3600	-3600	-2900	-2900	-2400	-700
2028	0.005	-1600	-1700	-3700	-1900	-3700	-3700	-3700	-2900	-2900	-2500	-700
2029	0.006	-1700	-1700	-3200	-2000	-3200	-3200	-3200	-2800	-2800	-2300	-600
2030	0.001	-1800	-1800	-3600	-1900	-3600	-3600	-3600	-3100	-3100	-2900	-1300
2031	0.004	-1700	-1700	-2800	-1900	-2800	-2800	-2800	-2500	-2500	-2400	-1200
2032	0.010	-1600	-1600	-2000	-1700	-2000	-2000	-2000	-1800	-1800	-1800	-1000
2033	0.022	-1000	-1000	-1100	-1000	-1100	-1100	-1100	-1000	-1000	-1100	-800
2034	0.094	-50	-50	-50	-50	-50	-50	-50	-50	-50	-50	-50

Notes:

- Negative MW indicate the ZRAM—the amount of “perfect capacity” (MW) that can be **removed** from a zone (one zone at a time) without causing a violation of the LOLE criterion.
- Positive MW indicate the “Compensatory MW”—the amount of “perfect capacity” (MW) that can be **added** to a zone (one zone at a time) to bring the NYCA LOLE back to criterion.
- The generation pockets in Zone J and Zone K are not modeled in detail for this analysis.

Figure 26: Zonal Resource Adequacy Margins - ZRAM (MW)

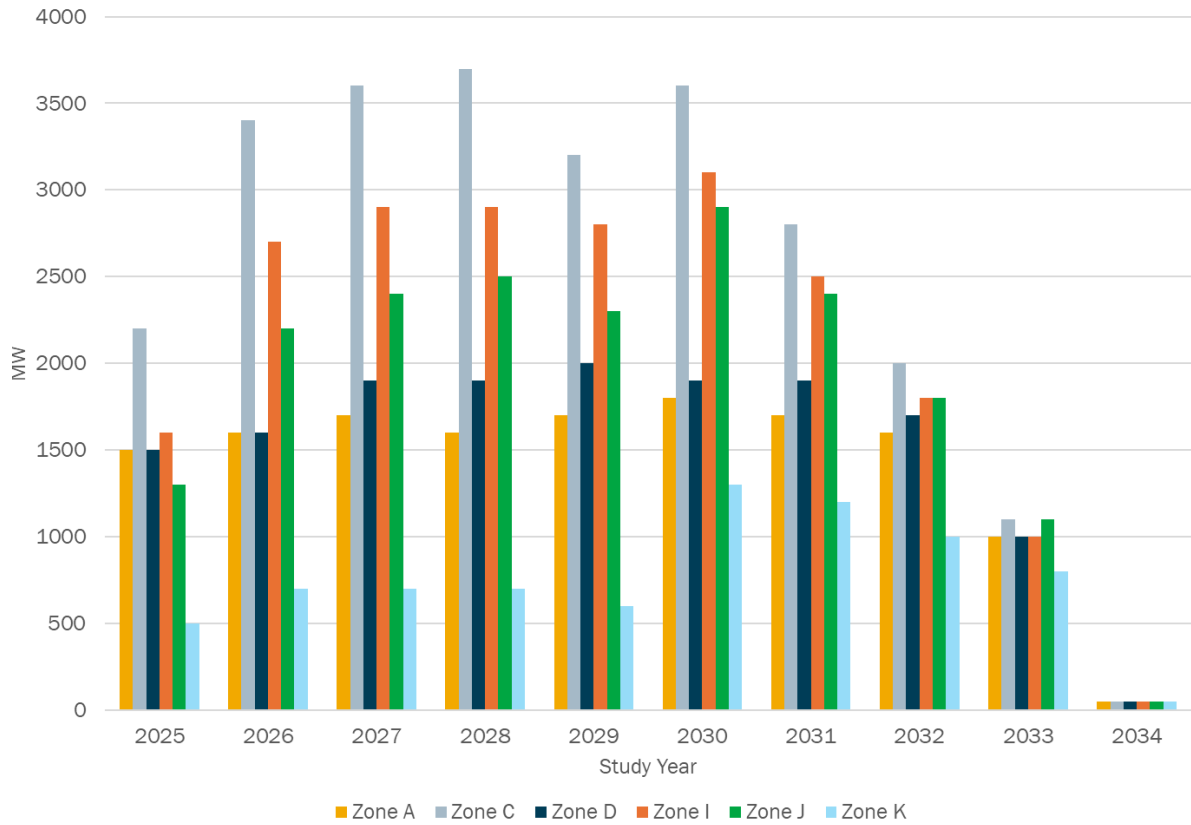

Statewide System Margin

Figure 27 and **Figure 28** shows decreasing summer and winter statewide margins during peak demand conditions to the point that the margin is deficient by 12 MW by summer of 2034 and 2,283 MW by the winter of 2034-35. A negative statewide system margin is not, on its own, a Reliability Criteria violation. It is, however, a leading indicator of the inability to securely meet system load under applicable normal system conditions, which is observed in the RNA transmission security results described in the next section.

Figure 27: Summer Peak Statewide System Margin

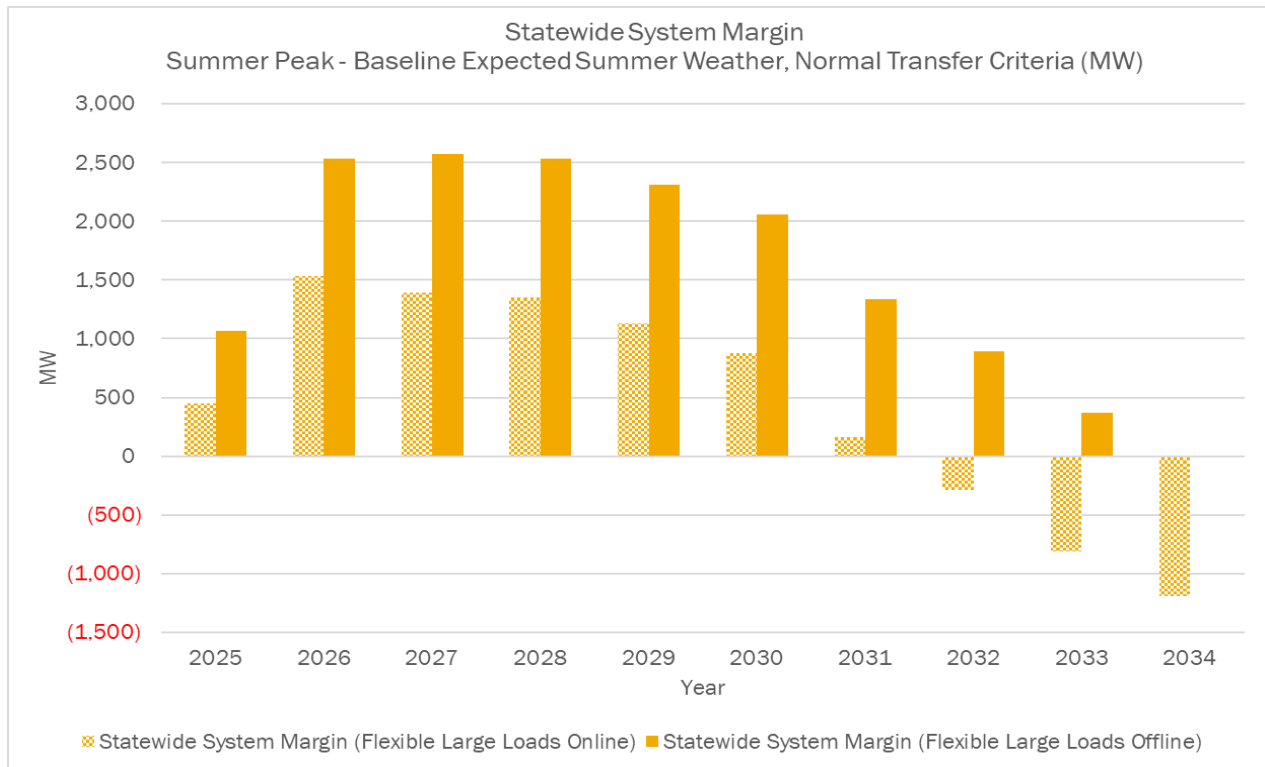
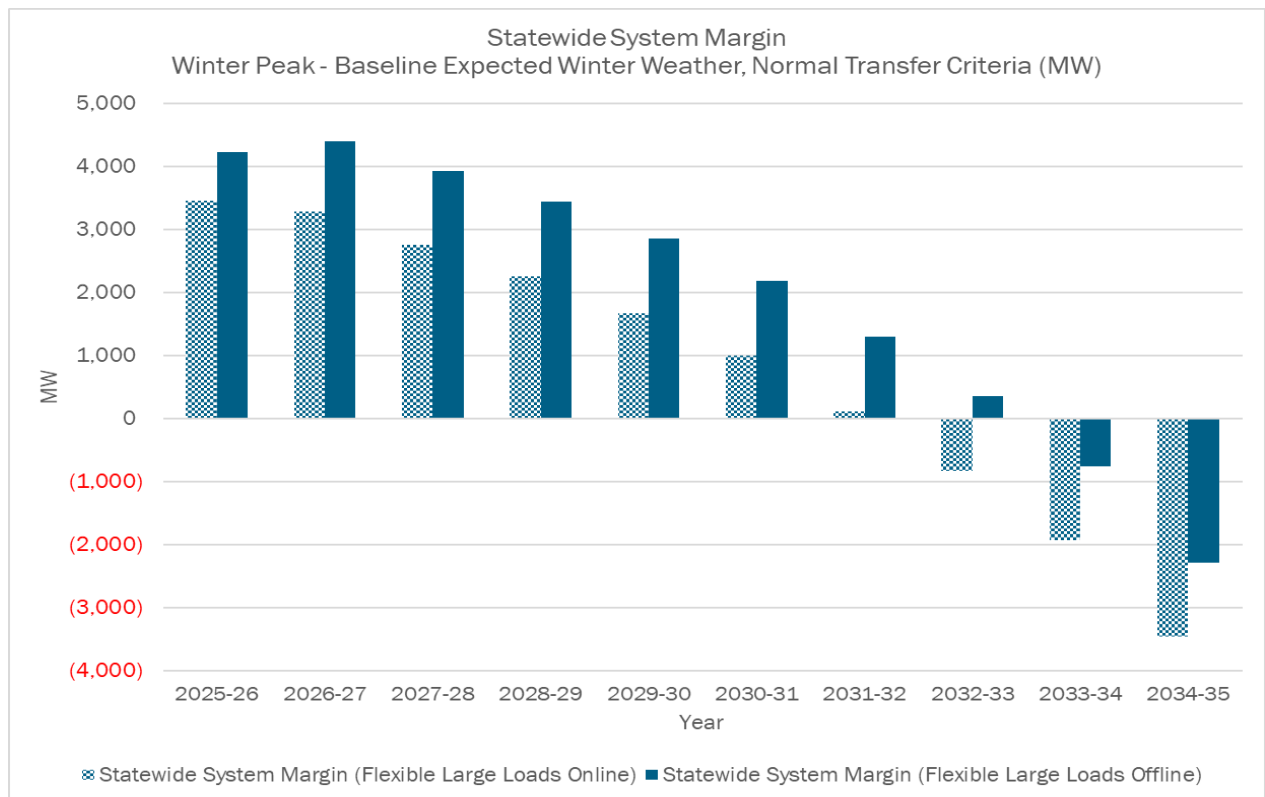

Figure 28: Winter Peak Statewide System Margin



Transmission Security Results

Transmission security analysis evaluates various credible combinations of system conditions that are expected to stress the system. As transmission security is inherently deterministic, boundary conditions are identified and then assessed. Specific to this RNA, the transmission security analysis included an assessment of summer peak, winter peak, and light load conditions under normal transfer criteria. In the establishment of these credible combinations of system conditions, typical transmission security cases for NYISO's reliability studies have at least 2,620 MW of reserve generation—an amount approximately twice the size of the largest loss of source event in the NYCA. This reserve allows for enough flexibility in the system to redispatch generation to avoid potential overloads in contingency analysis and mimics the 30-minute operating reserves maintained in real time operations. While 2,620 MW is typical, the power flow base cases must be modeled with a minimum reserve equal to at least one times the largest loss of source event (1,310 MW) in order to perform N-1-1 contingency analysis. The N-1-1 contingency analysis simulates the effect(s) of two contingency events—one following the other—on the system. Since the first contingency event can include the largest loss of source event, there must be sufficient reserve to return the system to a steady-state condition prior to simulating the second contingency event.

Forecasted peak load levels increase throughout the 2024 RNA study period such that the year 10 winter peak case (modeled with 6,400 MW of non-firm gas generation unavailable) had a 500 MW shortfall to serve all load. Considering the need to model reserve generation equal to the largest loss of source, there was a total shortfall of 1,800 MW that prevented the creation of a valid power flow case for use in N-1-1 contingency analysis. Not having enough generation in a power flow case to serve the forecasted peak load has never been experienced before this 2024 RNA in any of NYISO's transmission security studies.

In order to perform the transmission security analysis, the NYISO first addressed the 1,800 MW shortfall by accounting for the assumed flexibility of the large loads of 1,200 MW. Reducing 1,200 MW of flexible large loads only partially addressed this shortfall. Therefore, the NYISO modeled the reduction of a further 600 MW of load across the system. This 600 MW load reduction in the year 10 winter peak case is a modeling choice to complete transmission security analysis and does not necessarily reflect how NYISO would respond to such conditions if they were to occur in operations. **Figure 29** shows the duration and magnitude of load reduction that would be required during the winter peak day under these transmission security analysis assumptions.

Figure 29: 2034-2035 Winter Peak Day Reserve Levels

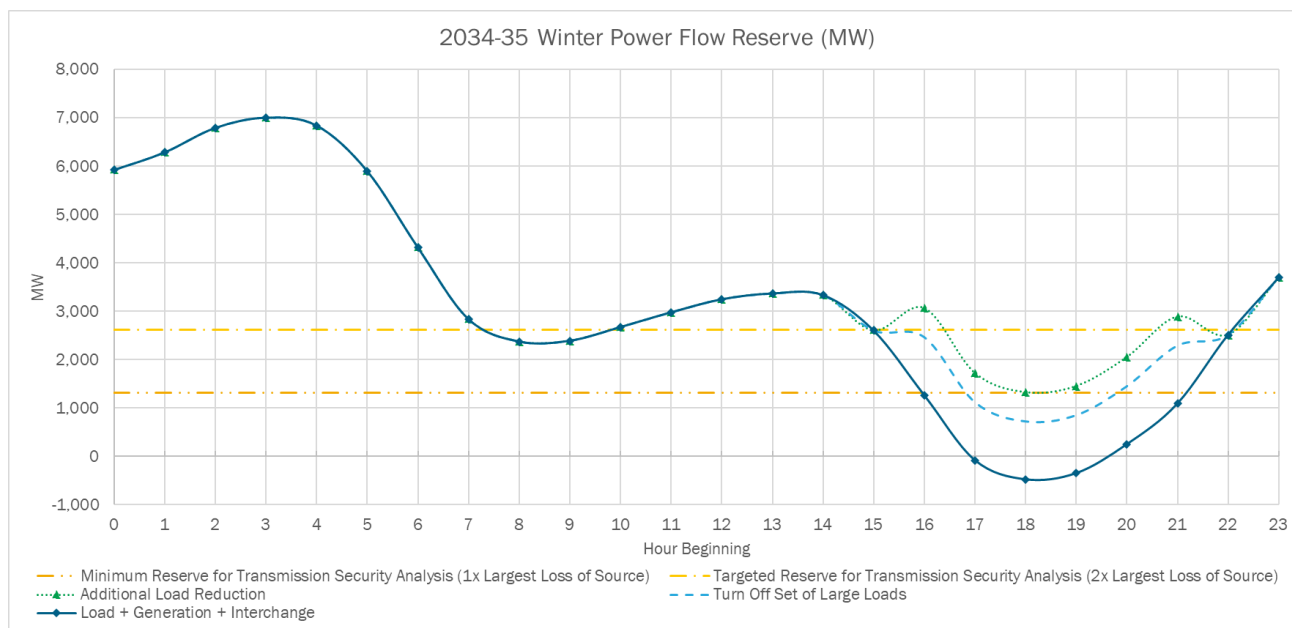

Reserve levels remain lower than in a typical power flow case even after load reductions. This low level of reserves restricts the ability of the model to redispatch the system around potential overloads in the contingency analysis. Consequently, potential thermal overloads were observed beginning in 2034-2035 winter under the case modeling assumptions described above. **Figure 30** provides a summary of the BPTF thermal overloads under N-1-1 conditions.

Figure 30: Winter Peak Steady State Transmission Security N-1-1 Thermal Overloads

Zone	Owner	Monitored Element	Norm Rating (MVA)	Cont Rating (MVA)	Worst 1st Contingency	Worst 2nd Contingency	Flow (%)
C	National Grid	Clay - Volney (6) 345 kV	1474	1626	Clay - Nine Mile 1 (8) 345 kV	Clay - Independence (26) 345 kV	101
C	National Grid	Clay - Volney (6) 345 kV	1474	1626	Clay - Independence (26) 345 kV	Clay - Nine Mile 1 (8) 345 kV	101
K	PSEG-LI	Barrett - Barrett OSW (2) 138 kV	213	305	Loss of Gas Fuel Supply at Cricket Valley	Barrett - Barrett OSW (1) 138 kV	121
K	PSEG-LI	Barrett - Barrett OSW (1) 138 kV	218	308	Loss of Gas Fuel Supply at Cricket Valley	Barrett - Barrett OSW (2) 138 kV	120
K	PSEG-LI	East Garden City - Newbridge (462) 138 kV	194	284	Loss of Gas Fuel Supply at Cricket Valley	Base Case	101

Investigation shows that the set of overloaded transmission elements are highly sensitive to changes in relative priorities given to resolve overloads in certain areas. While multiple valid dispatch choices exist, none can resolve all overloads simultaneously for a given first-level contingency. Resulting overloads are observed on lines leading out of the Barrett generation pocket in Long Island and/or lines leading out of the Oswego complex. These overloads indicate that the system is short of generation to serve load while respecting all transmission element ratings. Adjusting simulation priorities can mitigate certain line overloads, shifting the overloads to others, but there is no set of generation dispatches that results in a

system where all lines are within applicable ratings. Approximately 75 MW of compensatory resources are needed to fully resolve the observed thermal overloads. Testing shows that compensatory resources located anywhere in the NYCA can fully resolve the overloads.

While not as severe as in the winter peak case, increasing load levels resulted in a lower-than-typical reserve level modeled in the 2034 summer peak base case before considering the flexibility of certain large loads. Potential steady-state transmission security thermal overloads are also observed for the study period under 2034 summer peak conditions. **Figure 31** provides a summary of the BPTF overloads under N-1-1 conditions. These thermal overloads are observed beginning in the summer of 2033.

Figure 31: Summer Peak Steady State Transmission Security N-1-1 Thermal Overloads

Zone	Owner	Monitored Element	Norm Rating (MVA)	Cont Rating (MVA)	Worst 1st Contingency	Worst 2nd Contingency	Flow (%)	Flow (%) w/Flex Loads
C	National Grid	Clay - Volney 345 kV Line	1200	1396	Clay - Nine Mile 1 345 kV Line	Clay - Independence 345 kV Line	114	<100
C	National Grid	Clay - Nine Mile 1 345 kV Line	1032	1271	Clay - Volney 345 kV Line	Clay - Independence 345 kV Line	111	<100

These summer peak overloads can be mitigated by either modeling approximately 580 MW of compensatory resources or modeling the 1,200 MW of large load flexibility.

New York City Transmission Security Margin

A transmission security margin measures the ability to balance between the demand, scheduled imports, and resources available within a locality under applicable transmission criteria, while accounting for a credible combination of potential facility outages. A margin less than zero for a locality indicates that the BPTF may not operate reliably under the relevant conditions.

Within the Con Edison Transmission District, the 345 kV transmission system along with specific portions of the 138 kV transmission system are designed to criteria to address the occurrence of two non-simultaneous contingencies and a return to normal (N-1-1-0). Design criteria N-1-1-0 combinations include various losses of generation and transmission facilities.

As shown in **Figure 32**, the margin in the New York City locality will be deficient under the baseline expected summer weather forecast in 2033 and 2034. The deficiencies are due to increasing demand in New York City and the assumed retirement of the NYPA small gas plants.

Figure 32: New York City Transmission Security Margin

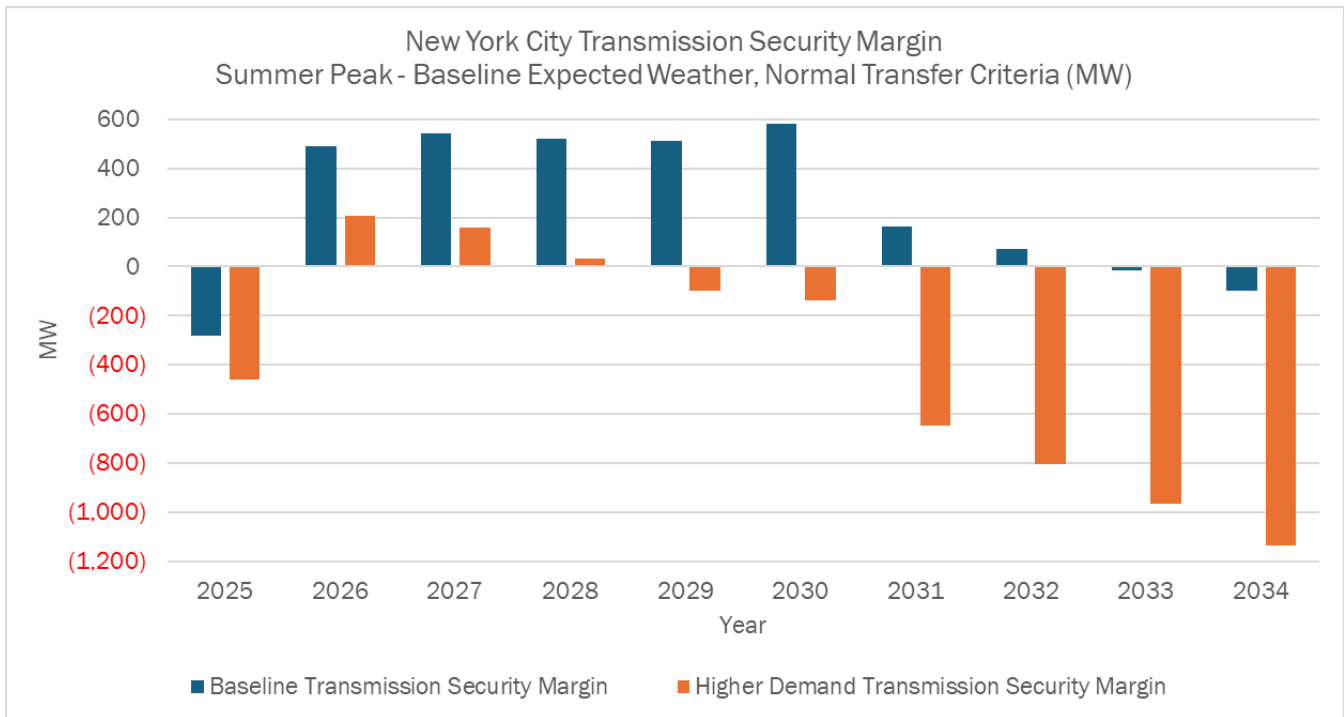

Under the baseline forecast for coincident summer peak demand, the New York City transmission security margin would be deficient starting in 2033 with the deficiency of 17 MW for one hour and growing to 97 MW for three hours in 2034. This assessment recognizes that there is uncertainty in the demand forecast driven by uncertainties in key assumptions such as population and economic growth, energy efficiency, the installation of BTM renewable energy resources, and electric vehicle adoption and charging patterns. These risks are considered in the transmission security margin calculations by incorporating the lower and higher forecast bounds as a range of conditions during expected weather. Accounting for uncertainties in key demand forecast assumptions, the higher bound of expected demand under baseline weather conditions (95 degrees Fahrenheit) in 2034 results in a deficiency of up to 1,137 MW over 11 hours.

Figure 33: New York City Transmission Security Margin Hourly Curve - 2034

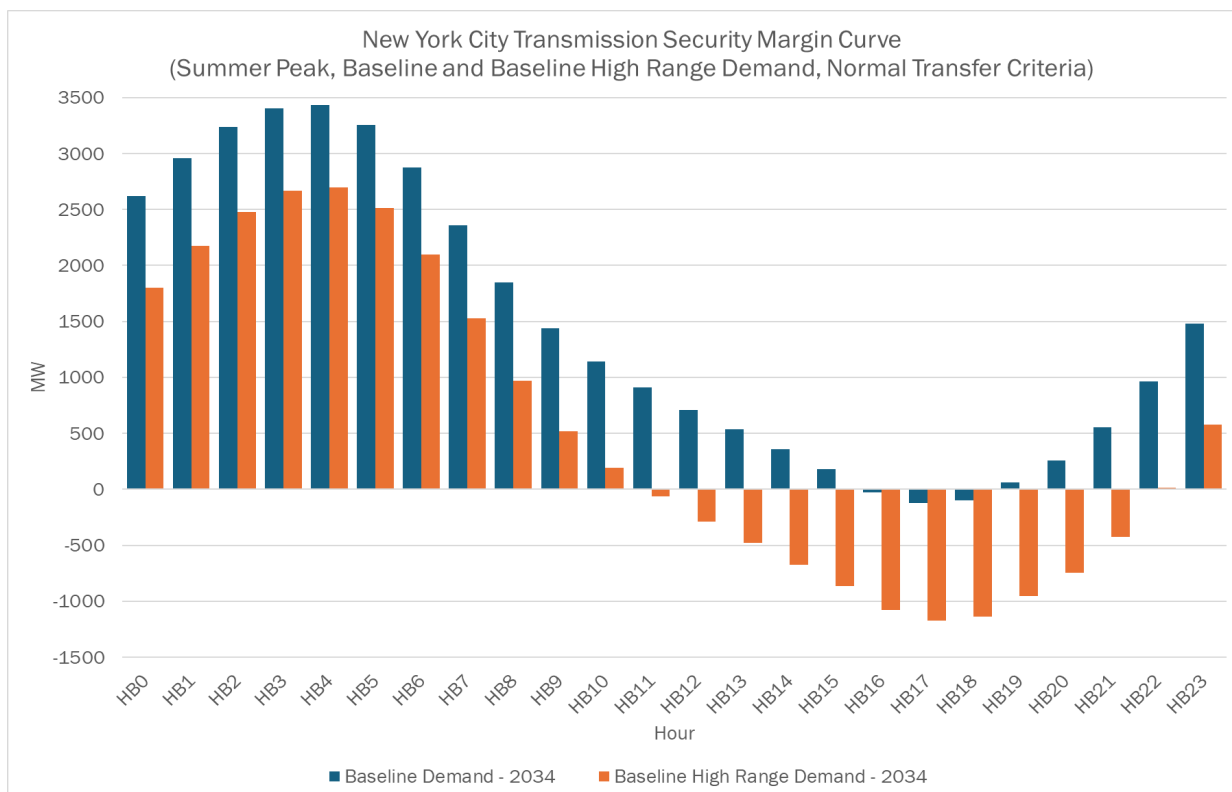

Appendix F contains additional details regarding the margin calculations for other localities, as well as the impact on the margins due to heatwaves, cold snaps, plant outages, and other system conditions, for informational purposes.

Local Non-BPTF Reliability Assessment

In addition to the assessment of the BPTFs conducted by the NYISO, Con Edison observed transmission security violations due to deficiencies observed in their non-bulk Greenwood 138 kV transmission load area (TLA). The observed deficiencies range from 150 MW to 300 MW depending on system conditions. These deficiencies, if not addressed, were found to propagate to neighboring TLAs, such as the Vernon 138 kV TLA.

The Greenwood TLA, shown in **Figure 34**, depends on power imports from the boundary substations and the generation connected within the TLA. Con Edison’s assessment assumed that the Gowanus 2 & 3 and Narrows 1 & 2 barges are unavailable for the Summer Operating Season, starting in 2026, and the NYPA small gas plants are unavailable starting in 2031. While this RNA does not identify a Reliability Need for the Greenwood TLA, these conditions will continue to be assessed and reported through quarterly STARS and Con Edison’s local transmission owner plans.

Figure 34: Greenwood 138 kV TLA

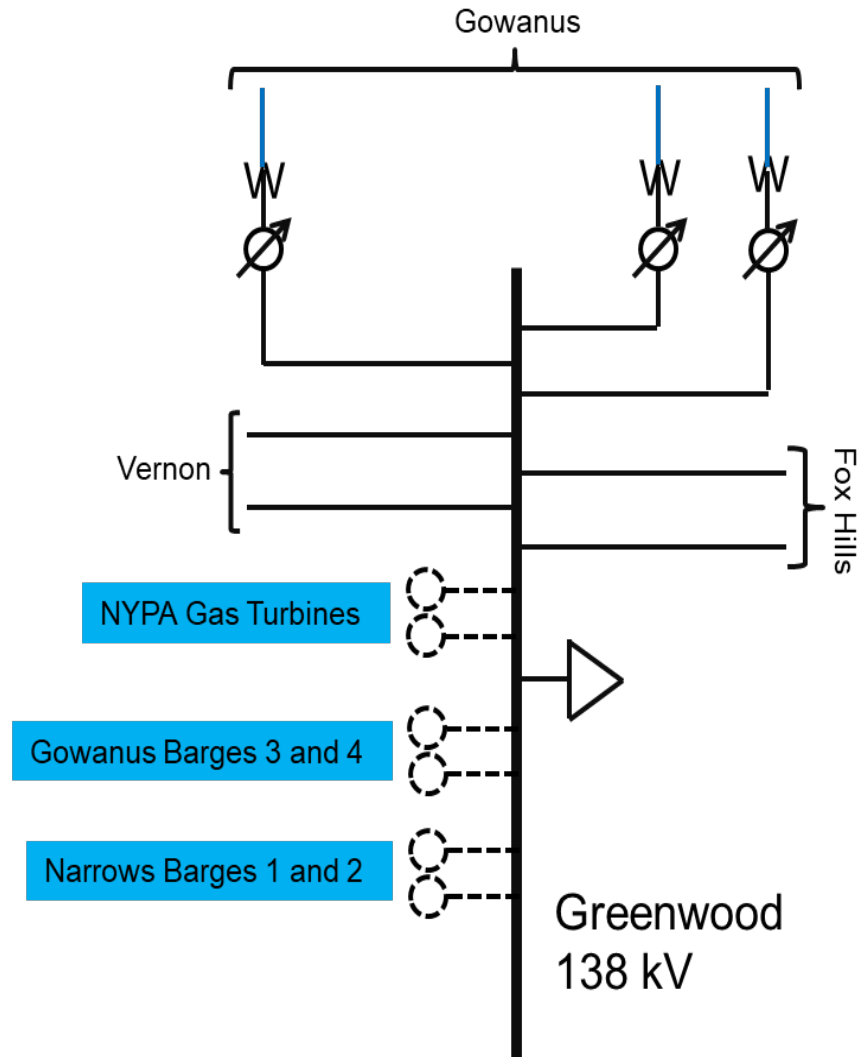

Starting in 2026, thermal overloads and voltage violations are observed on the Greenwood 138 kV TLA boundary feeders in the steady state (N-0) condition, which are exacerbated under N-1 and N-1-1 conditions. Considering the utilization of all available PAR controls, the observed deficiency within this TLA is between 240 MW in 2026 to 300 MW in 2031 as shown in **Figure 35**. The deficiency drops in 2032 and 2034 due to Con Edison’s planned load transfers on the distribution system.

Figure 35: Greenwood 138 KV TLA Deficiency

Year	2025	2026	2027	2028	2029	2030	2031	2032	2033	2034
Deficiency (MW)	-	240	240	240	240	280	300	220	250	150

Exploring Uncertainty: Scenarios and Risks

The NYISO, in conjunction with stakeholders and Market Participants, developed reliability scenarios pursuant to Section 31.2.2.5 of the OATT. Scenarios are variations on the RNA Base Case to assess the impact of possible changes in key study assumptions which, if they occurred, could change the timing, location, or degree of violations of Reliability Criteria on the NYCA system during the study period. Scenarios are used to represent the inherent uncertainty in various key system trends underlying the study assumptions and help to highlight potential reliability risks if the future differs from the base case assumptions. Scenarios are informative and cannot be used to identify actionable Reliability Needs.

For the 2024 RNA, the NYISO performed six scenarios. Each scenario varies one significant assumption of the RNA Base Case, which models 1,200 MW of large loads as flexible during peak demand system conditions. Some scenarios—*i.e.*, Additional Queue Projects, Offshore Wind, and Additional Firm Gas Generation—are helpful to inform potential solutions to identified Reliability Needs and reliability risks. These scenarios focus more on the final year of the study period when the New York City deficiency and statewide resource constraints are observed to occur. Other scenarios—*i.e.*, Higher Demand Forecast, CHPE Delay, Retirements—represent additional risks to show when potential reliability violations could occur under that scenario.

Additional Queue Projects Scenario

The 2024 RNA Base Case includes 2,750 MW of resource additions but does not reflect the total amount of projects in the pipeline. This scenario adds roughly 5,000 MW of additional generation projects, which have accepted their Class Year cost allocations but have not yet meet the Base Case inclusion rules, to evaluate the impact to the potential resource shortfalls identified in the Base Case. The additional generation includes approximately 2,400 MW of solar, 1,600 MW of land-based wind, and 1,000 MW of storage projects. While not all of the projects that accept their Class Year cost allocations may come into service, this scenario provides additional information on a subset of additional resources in the pipeline that could be in service by 2034 when the RNA forecasts tightening margins.

From a resource adequacy perspective, the additional projects would lower the NYCA LOLE well below criterion, as shown in the figure below.

Figure 36: Additional Queue Projects Scenario NYCA LOLE Results

	Base Case	Solution Scenario
Study Year	With Large Load Flexibility	Additional Proposed Projects (5,000 MW)
2034	0.094	0.030

From a transmission security perspective, the additional generation projects would contribute 1,850 MW in summer peak and 1,750 MW in winter peak across the state considering transmission security renewable dispatch assumptions. These additional projects would mitigate the overloads observed in the winter peak case. For both summer and winter, no new thermal, voltage, or stability criteria violations were observed. The New York City transmission security margin would be sufficient in the summer of year 10 of the study period. However, this conclusion assumes that the Zone J battery storage in this scenario is available to inject throughout the duration of the deficiency.

Offshore Wind Scenario

The RNA Base Case models less than 2,000 MW of offshore wind connected to New York City and Long Island and does not account for the additional offshore wind projects currently under development to meet 9,000 MW of offshore wind by 2035 under the CLCPA. This scenario models a total of 6,000 MW of offshore wind generation in New York City and 3,000 MW of offshore wind generation in Long Island by 2034.

From a resource adequacy perspective, the additional projects lowered the NYCA LOLE well below criterion, as shown in the figure below.

Figure 37: Additional Offshore Wind Scenario NYCA LOLE Results

	Base Case	Solution Scenario
Study Year	With Large Load Flexibility	Additional Offshore Wind (7,000 MW)
2034	0.094	0.031

From a transmission security perspective, the additional offshore wind generation would contribute 518 MW in New York City and 194 MW in Long Island considering transmission security renewable dispatch assumptions in the summer peak case. The New York City transmission security margin would be no longer deficient in summer 2034 after considering this additional offshore wind generation. In winter 2034-35, the additional MW availability contributed to 1,036 MW in New York City and 388 MW in Long Island. The MW shortfall and overloads found in the winter peak for the RNA Base Case would be eliminated by the additional offshore wind generation.

Additional Firm Gas Generation Scenario

For the first time, the RNA Base Case models the unavailability of non-firm gas generation during winter peak conditions in response to the NYSRC’s reliability rule. Combined with the increasing winter peak demand, the assumption of the unavailability of non-firm gas generation is a driving factor in the decreasing margins in the outer years of the 2024 RNA. This scenario looks at the effect on the RNA results if the 6,400 MW assumed reduction were decreased by 700 MW. This difference in the amount of unavailable non-firm gas could represent generation obtaining firm fuel or dual fuel capability, as incentivized by the NYISO capacity accreditation rules. The scenario also acknowledges that there is uncertainty around the future gas availability for electric generation and that the assumptions around this constraint are likely to change over time based on further developments and operating experience.

From a resource adequacy perspective, the availability of an additional 700 MW would lower the NYCA LOLE well below criterion.

Figure 38: Additional Firm Gas NYCA LOLE Results

Study Year	Base Case	Additional 700 MW Firm Gas
2034	0.094	0.049

From a transmission security perspective, the addition of 700 MW of capacity would eliminate MW shortfall and overloads found in the winter peak for the RNA Base Case.

Demand Response in Transmission Security Scenario

Transmission security analysis performed under normal transfer criteria does not account for Special Case Resources (SCRs) that may be called upon to relief load. However, load flexibility (via SCRs, DERs, or other demand response programs) could contribute significantly to system reliability when needed. This scenario looks at the impact of 1,200 MW of flexible demand (beyond the flexible large loads) across the system on the transmission security results. To reflect uncertainty in demand response participation, a

generic 50% derate is modeled.

Of the 1,200 MW of flexible demand, about 500 MW is assumed to be in Zone J. At the generic derate factor, this would result in 250 MW of load reduction and would resolve the New York City transmission security margin deficiency in the peak hour. In winter 2034-35, the MW shortfall to build the power flow case would be addressed but it would not free up enough generation reserves to mitigate the winter peak overloads.

High Demand Forecast Scenario

The RNA utilizes forecasts from the 2024 Gold Book, which contains multiple forecast scenarios, including the baseline forecast. All forecasts account for drivers, such as economic growth, energy efficiency, behind-the-meter load-reducing resources, large loads, and electrification. The higher demand scenario represents a higher bound on forecast growth, including faster economic growth and electrification sufficient to meet state policy targets, and includes additional large load growth not included in the baseline forecast.

Figure 39: Baseline Demand Forecast vs High Demand Forecast (MW)

Summer				Winter			
Year	Baseline	High Demand	Delta	Year	Baseline	High Demand	Delta
2025	31,650	32,200	550	2024-25	23,800	24,050	250
2026	31,900	32,910	1,010	2025-26	24,210	24,960	750
2027	32,110	33,450	1,340	2026-27	24,730	25,790	1,060
2028	32,130	33,940	1,810	2027-28	25,270	26,690	1,420
2029	32,340	34,400	2,060	2028-29	25,760	27,610	1,850
2030	32,580	34,910	2,330	2029-30	26,350	28,560	2,210
2031	32,880	35,480	2,600	2030-31	27,020	29,650	2,630
2032	33,320	36,130	2,810	2031-32	27,900	30,960	3,060
2033	33,830	36,810	2,980	2032-33	28,850	32,540	3,690
2034	34,210	37,480	3,270	2033-34	29,950	34,350	4,400

From a resource adequacy perspective, the high demand forecast would result in NYCA LOLE violations starting 2032.

Figure 40: High Demand Scenario NYCA LOLE

Sudy Year	Base Case	High Demand Scenario
2025	0.024	0.036
2026	0.006	0.013
2027	0.006	0.015
2028	0.005	0.016
2029	0.006	0.028
2030	0.001	0.026
2031	0.004	0.081
2032	0.010	0.298
2033	0.022	1.328
2034	0.094	2.744

From a transmission security perspective, the high demand forecast is 3,270 MW higher for NYCA in summer compared to the base demand forecast—1,040 MW of which is in Zone J. The higher loads would exacerbate the MW shortfall problems with modeling adequate reserves when building both the summer peak and winter peak cases and would likely result in additional thermal overloads due to reduced system flexibility. The New York City transmission security deficiency would grow to 1,137 MW in year 10 of the study period.

CHPE Unavailability Scenario

This scenario acknowledges that delays can occur throughout the entire developmental life cycle of a proposed generation or transmission project. The CHPE project is currently assumed to be in service for the Summer Capability Period in 2026. This scenario delays the CHPE project from entering service until after this RNA’s study period. It also informs of the impact if CHPE cannot inject power into New York City during summer peak conditions.

From a resource adequacy perspective, a delay in the CHPE project beyond the RNA planning horizon would result in an LOLE violation occurring in 2034.

Figure 41: Scenario without CHPE LOLE Results

Study Year	Base Case	Without CHPE Scenario
2025	0.024	0.024
2026	0.006	0.014
2027	0.006	0.010
2028	0.005	0.008
2029	0.006	0.010
2030	0.001	0.005
2031	0.004	0.014
2032	0.010	0.029
2033	0.022	0.044
2034	0.094	0.119

From a transmission security perspective, the delay of the CHPE project would lower the level of reserve available and would reduce dispatch flexibility. The year 10 summer peak thermal violations would likely increase such that the flexibility of large loads would no longer eliminate the thermal violations observed in the Base Case. Without the CHPE project, the New York City transmission security deficiency would occur beginning in year 2 and continue through year 10 with a maximum deficiency of 797 MW in 2034. The CHPE project is scheduled at 0 MW in winter peak conditions. Therefore, the delay of CHPE would have no impact to the winter peak power flow MW shortfall.

Additional Generation Retirements Scenario

As generators age and experience more frequent and longer duration outages, the costs to maintain the assets increase. These costs may drive aging generation into retirement, especially in the case of the fossil fleet that faces increasing restrictions on emissions in the future. A growing amount of New York's gas-turbine and fossil fuel-fired, steam-turbine capacity is reaching an age at which, nationally, the majority of similar capacity has been deactivated. **Figure 42** shows that by 2028, more than 6,500 MW of gas-turbine and steam-turbine based capacity in New York will reach an age beyond which 95% of these types of generators have deactivated.

Figure 42: Aging Fossil Fuel Capacity

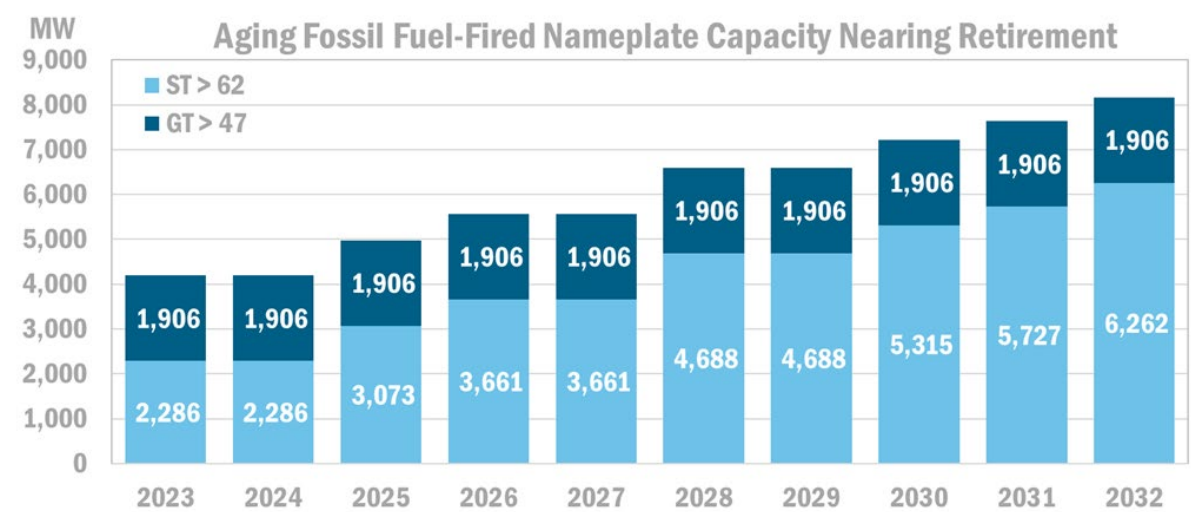

While the NYISO assumes existing generators to be in the Base Case unless they meet the current RNA deactivation rules in the Reliability Planning Process Manual, this scenario is intended to show the impact of additional generation deactivations. Figure 43 shows the impact of the retirement of the largest plant in each of the Lower Hudson Valley (Ravenswood 1, 2, and 3), New York City (Ravenswood 1, 2, and 3), and Long Island (Northport 1, 2, 3, and 4) localities. The modeling of these units as unavailable was not based on specific deactivation plans but highlights the risk to system reliability should generation retire without adequate replacements. Appendix G shows the impact of additional generator retirements on the transmission security margins.

Figure 43: Impact of Potential Retirements

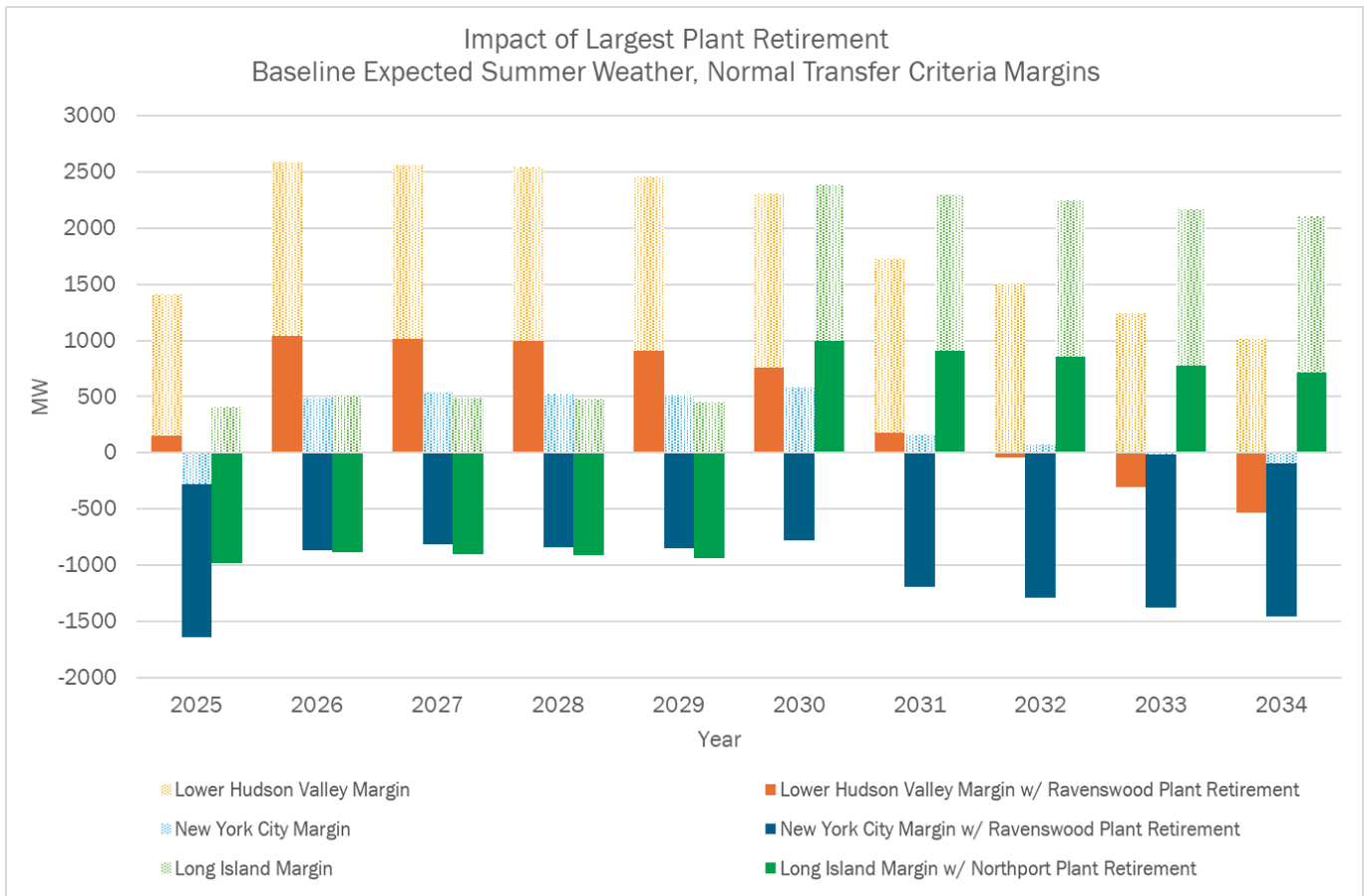

Findings

New York City Reliability Need

This 2024 RNA finds a Reliability Need beginning in summer 2033 within New York City primarily driven by a combination of forecasted increases in peak demand and the assumed retirement of the NYPA small gas plants. Accounting for these factors, the BTPFs will not be able to securely and reliability serve the forecasted demand in New York City. Zone J will be deficient by 17 MW for 1 hour in summer 2033 and rising to 97 MW for 3 hours in summer 2034 on the peak day during expected weather conditions when accounting for forecasted economic growth and policy-driven increases in demand.

Figure 44: New York City Margin Forecast Uncertainty

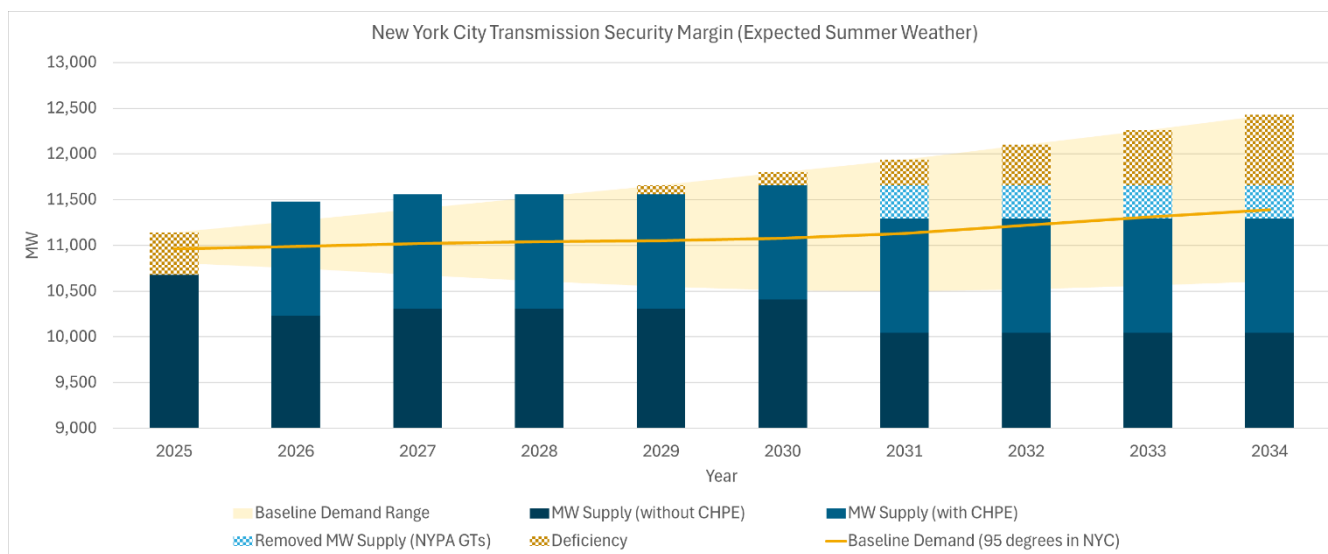

Furthermore, Con Edison has identified reliability violations in the Greenwood 138 kV transmission load area. These violations are on non-BPTF elements and, therefore, are not identified as Reliability Needs in this RNA. However, it is important to holistically consider the reliability of the BPTF and non-BPTF when identifying solutions.

The Reliability Need could be met by combinations of solutions including new generation, retention of planned generation retirements, transmission, energy efficiency, demand response measures, or changes in operating protocols. Specifically, scenarios performed in the RNA indicate that the New York City transmission security deficiency could be resolved by resources currently under development but not yet in the Base Case. Other scenarios suggest that the transmission security deficiency could be much greater if the load higher load or there are more unplanned generator retirements than assumed in the Base Case.

Reducing Statewide Reliability Margins

This 2024 RNA does not find a statewide resource adequacy Reliability Need. Although this RNA does not find a violation of the resource adequacy criterion, the LOLE by 2034 is extremely close to the 0.1 event-days per year criterion. This resource constraint is also observed in novel ways in the transmission security analysis. Specifically, there are not enough generation reserves modeled in the power flow cases to resolve N-1-1 overloads. These results are a function of not being able to build the power flow case with sufficient system flexibility rather than representing specific transmission security constraints. Accordingly, the tightening margins are a significant concern that the NYISO will closely monitor and re-evaluate in future STARS and the next cycle of the Reliability Planning Process.

Uncertainty in the Planning Horizon

A key finding of this 2024 RNA is that there is increasing uncertainty about key system trends over the next 10 years. The scenarios summarized below in **Figure 45** demonstrate how the identified Reliability Need in New York City and the tightening statewide resource constraints can be either resolved or exacerbated based on variety of factors.

Figure 45: Scenario Reliability Margins

2034 Reliability Metric	Base Case		Mitigation Scenarios				Risk Scenarios	
	Preliminary Base Case w/o Large Load Flexibility	Final Base Case with Large Load Flexibility	SCR/DERs (1,200 MW)	Non-firm Gas (700 MW)	OSW (additional 7,000 MW)	Additional Q Projects (5,000 MW)	High Demand	CHPE Delay
LOLE (event-days/year)	0.289	0.094	0.094	0.049	0.031	0.030	2.744	0.119
Winter Peak Power Flow Margin (MW)	-1875	-675	-190	25	725	1075	-5565	-675
Summer Peak Power Flow Margin (MW)	-580	620	1410	620	1320	2470	-2650	-630
Summer NYC TSM (MW)	-97	-97	142	-97	421	868	-1137	-797

Through the Reliability Planning Process and Short-Term Reliability Process, the NYISO will continue to monitor system developments and update assumptions as new information becomes available. The RNA is followed by the Comprehensive Reliability Plan where the NYISO will continue to explore the grid trend uncertainties highlighted in this RNA. These trends could potentially lead to the identification of new reliability needs in the 2025 STARS, which will be conducted quarterly, and the 2026 RNA.

The following are key considerations for the 2025-2034 CRP and future planning studies:

- For the first time in NYISO planning studies, the RNA observed resource shortfalls in the year

10 power flow cases that resulted in overloads due to decreased system flexibility. The NYISO will coordinate with reliability organizations (i.e., NYSRC, NPCC, NERC) on best practices to address transmission security results driven by resource deficiencies.

- While the RNA Base Case included a limited set of new generation projects, there is significant development of new resources across New York State. Ongoing efforts—such as projects with interconnections requests undergoing study in Class Year 2023 and NYSERDA large-scale renewable, offshore wind, and storage procurements—are expected to result inclusion of many generator projects in future reliability studies.
- The flexibility of certain large loads is modeled in system peak conditions to reflect their characteristics based on communications with load developers and recent operating experience. However, this is a quickly evolving trend and the NYISO will as they come into service. The NYISO will monitor the speed and type of load interconnection and adjust modeling practices as necessary.
- Competitive wholesale energy, ancillary services, and capacity markets are fundamental to providing consumers reliable, lowest-cost power and are essential tools for achieving public policy. The winter reliability risks identified in the RNA demonstrate the importance of firm-fuel contracts and dual fuel generation based on its contribution to reliability during potential periods of gas fuel shortages during increasing winter peak demand. Capacity accreditation and energy security studies are expected to influence future winter risk assumptions.
- On the demand-side, potential market rule changes to SCRs and DERs could affect how demand flexibility (including large loads) can be reflected in reliability studies.

Next Steps and Future Studies

The NYISO designed its Reliability Planning Process to allow for updates in key assumptions and continuous evaluation of an everchanging system. The RNA and CRP are part of a biennial planning cycle, while the STARs are performed every 90 days, as also depicted in the figure below.

Figure 46: Reliability Planning Process

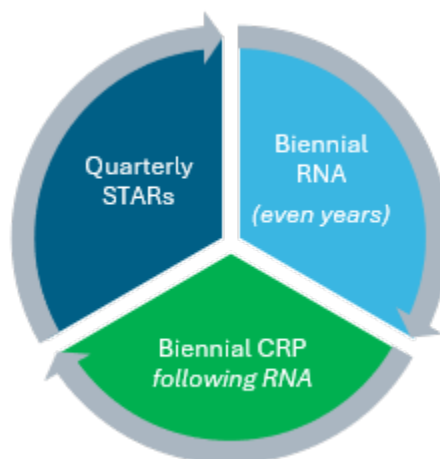

This 2024 RNA finds that there is a Reliability Need on the BPTFs in New York City for study years 2033 and 2034 due to transmission security Reliability Criteria violations. The Reliability Need occurs within Con Edison’s transmission district in New York City (Zone J). Therefore, the NYISO designates Con Edison as the Responsible Transmission Owner, as defined by the NYISO OATT. The following are the next steps to be taken in the Reliability Planning Process.

RNA Base Case Update: Following approval of this 2024 RNA by the Board of Directors, the NYISO will incorporate eligible system updates to the RNA Base Case. Such system updates can include status changes of proposed projects, such as Local Transmission Owner Plans (LTPs), proposed generation and transmission, and load forecast or demand response. As part of this step, the NYISO will consider only those updates that may reduce or eliminate the Reliability Needs and that met the inclusion rules.

Solution Solicitation and Initial Review: If any Reliability Need remains after these Base Case updates, the NYISO will solicit market-based solutions, regulated backstop solutions, and alternative regulated solutions to address the remaining Reliability Needs. Interested Developers can submit solutions within 60 calendar days from the solicitation. The Responsible Transmission Owner(s) must submit regulated backstop solution(s) to address the applicable Reliability Need(s). Any Transmission Owner or Other Developer can submit an alternative regulated solution, and any Developer can submit a market-based solution. The NYISO will review the solutions for completeness.

Viability and Sufficiency Assessments: The NYISO will evaluate whether each proposed solution is viable and is sufficient to satisfy the identified Reliability Need by the need date. The NYISO considers all resource types—generation, transmission, demand response, or a combination of these resource types—on a comparable basis as potential solutions to the identified Reliability Need. All solutions will be evaluated in the same general timeframe. The NYISO will identify any reliability deficiencies in proposed regulated solutions and afford a 30-day opportunity for the Transmission Owner or Other Developer to address the deficiency.

Establishment of Trigger Date of Proposed Regulated Solutions: In addition to reviewing proposals for completeness, viability, and sufficiency, the NYISO will notify all Developers if any received regulated solution has proposed an implementation lead time that could result in a Trigger Date within 36 months of the date of the NYISO's presentation of the Viability and Sufficiency Assessment to the ESPWG. A Trigger Date is the date by which the NYISO must request the Transmission Owner or Other Developer to begin implementing the regulated solution in order to meet the Reliability Need. The NYISO will independently analyze the lead time proposed by each Developer for the implementation of its regulated solution. The NYISO will use the Developer's estimate and the NYISO's analysis to establish the NYISO's Trigger Date for each regulated solution. The NYISO will also establish benchmark lead times for proposed market-based solutions.

Viability and Sufficiency Report: The NYISO will present its Viability and Sufficiency Assessment to stakeholders, interested parties, and the NYDPS for comment and will indicate at that time whether any of the proposed regulated solutions found to be viable and sufficient will have a Trigger Date within 36 months of the date of the NYISO's presentation of the Viability and Sufficiency Assessment to the ESPWG.

Evaluation and Selection of Proposed Regulated Transmission Solutions: If the NYISO determines that the Trigger Date of any proposed regulated solution that it found to be viable and sufficient will occur within 36 months of the date of the NYISO's presentation of the Viability and Sufficiency Assessment to the ESPWG, the NYISO will request that the Developers of the viable and sufficient regulated transmission solutions to submit to the NYISO further project information as detailed in the tariff for: (i) a proposed regulated backstop transmission solution or (ii) a proposed alternative regulated transmission solution. Developers will have 30 days to submit further project information to the NYISO for the regulated transmission solution to be eligible for selection as the more efficient or cost-effective solution to the Reliability Need in the planning cycle.

If the NYISO determines that none of the proposed regulated solutions that it found viable and sufficient has a Trigger Date that will occur within 36 months of the date of the NYISO's presentation of

Viability and Sufficient Assessment to the ESPWG, the NYISO will not request further information, perform the evaluation, or select the more efficient or cost-effective regulated transmission solution for the planning cycle.

The Comprehensive Reliability Plan is prepared, in collaboration with stakeholders and interested parties, each planning cycle and reports on whether the BPTF will meet all applicable Reliability Criteria over the planning horizon. When the NYISO solicits solutions to a Reliability Need, the CRP documents the NYISO's findings regarding the viability and sufficiency of proposed solutions, the Trigger Dates of proposed regulated solutions, and any recommendations on the implementation of regulated solutions to maintain system reliability. If the NYISO determines at the time of the issuance of the CRP that sufficient market-based solutions will not be available in time to meet a Reliability Need and finds that it is necessary to take action to ensure reliability, it will state in the CRP that the development of regulated solutions (regulated backstop or alternative regulated solution) is necessary.

Short-Term Reliability Process: In addition to the studies in the Reliability Planning Process, the Short-Term Reliability Process will continue to evaluate the reliability of the New York system through the quarterly Short-Term Assessments of Reliability (STARs). Any reliability needs identified in year 1 through year 3 in a STAR will be addressed using the Short-Term Reliability Process. Reliability needs identified in years 4 and 5 will only be addressed using the Short-Term Reliability Process if the identified need cannot timely be addressed through the next cycle of the Reliability Planning Process.